

JVC

DIGITAL VIDEO CAMERA

GR-DX307

Please visit our Homepage on the World Wide Web for Digital Video Camera:

<http://www.jvc.co.jp/english/cyber/>

For Accessories:

<http://www.jvc.co.jp/english/accessory/>

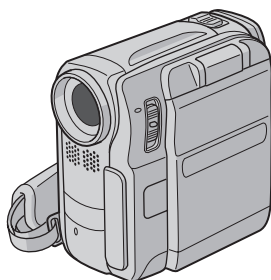

Mini **DV** NTSC



MultiMediaCard

INSTRUCTIONS

Dear Customer,

Thank you for purchasing this digital video camera. Before use, please read the safety information and precautions contained in the pages 3 – 4 to ensure safe use of this product.

ENGLISH

GETTING STARTED 6

VIDEO RECORDING & PLAYBACK 15

DIGITAL STILL CAMERA (D.S.C.) RECORDING & PLAYBACK 21

ADVANCED FEATURES 27

REFERENCES 45

TERMS Back cover

For Customer Use:

Enter below the Model No. and Serial No. which is located on the bottom of the camcorder. Retain this information for future reference.

Model No. _____

Serial No. _____

To deactivate the demonstration, set "DEMO MODE" to "OFF".

(☞ pg. 27, 29)

LYT1309-001A

EN

Major Features of this Camcorder

Wipe/Fader Effects

You can use the Wipe/Fader Effects to make pro-style scene transitions. (☞ pg. 34)

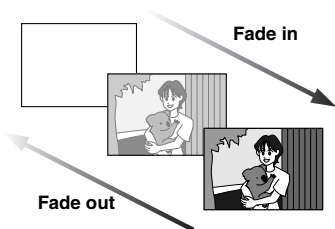

Program AE with Special Effects

For example, "SPORTS" mode allows fast-moving images to be captured one frame at a time, for vivid, stable slow-motion. (☞ pg. 35)

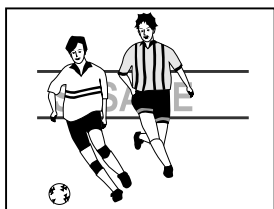

LED Light

You can brighten the subject in the dark place with the LED Light. (☞ pg. 31)

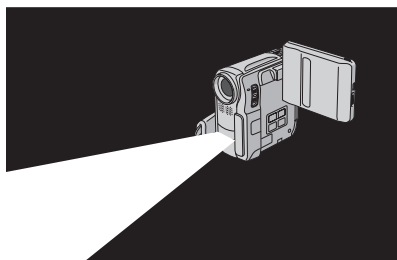

Backlight Compensation

Simply pressing the **BACK LIGHT** button brightens the image darkened by backlight. (☞ pg. 33)

- You can also select a spot metering area so that more precise exposure compensation is available. (☞ pg. 33, Spot Exposure Control)

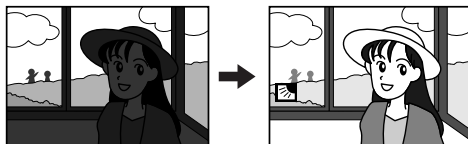

Navigation Function

The Navigation Function helps you check tape contents by making thumbnail images on a memory card. (☞ pg. 35)

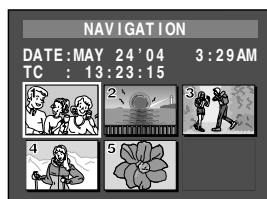

E-Mail Clip Recording

You can record video clips on the memory card as files which can be sent via e-mail. (☞ pg. 24)

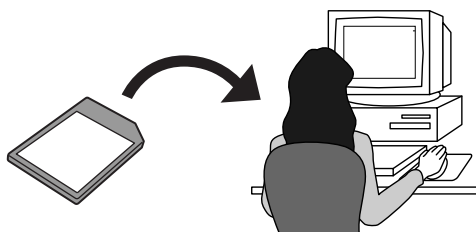

SAFETY PRECAUTIONS

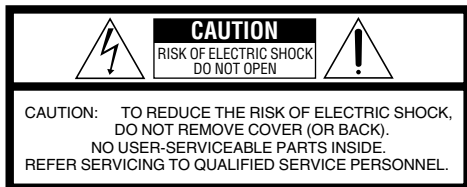

The lightning flash with arrowhead symbol, within an equilateral triangle, is intended to alert the user to the presence of uninsulated "dangerous voltage" within the product's enclosure that may be of sufficient magnitude to constitute a risk of electric shock to persons.



The exclamation point within an equilateral triangle is intended to alert the user to the presence of important operating and maintenance (servicing) instructions in the literature accompanying the appliance.

WARNING: TO PREVENT FIRE OR SHOCK HAZARD, DO NOT EXPOSE THIS UNIT TO RAIN OR MOISTURE.

CAUTIONS:

- This camcorder is designed to be used with NTSC-type color television signals. It cannot be used for playback with a television of a different standard. However, live recording and LCD monitor/viewfinder playback are possible anywhere.
- Use the JVC BN-V107U/V114U battery packs and, to recharge them or to supply power to the camcorder from an AC outlet, use the provided multi-voltage AC Adapter. (An appropriate conversion adapter may be necessary to accommodate different designs of AC outlets in different countries.)

Caution on Replaceable lithium battery

The battery used in this device may present a fire or chemical burn hazard if mistreated.

Do not recharge, disassemble, heat above 100°C (212°F) or incinerate.

Replace battery with Panasonic (Matsushita Electric), Sanyo, Sony or Maxell CR2025.

Danger of explosion or Risk of fire if the battery is incorrectly replaced.

- Dispose of used battery promptly.
- Keep away from children.
- Do not disassemble and do not dispose of in fire.

NOTES:

- The rating plate (serial number plate) and safety caution are on the bottom and/or the back of the main unit.
- The rating information and safety caution of the AC Adapter are on its upper and lower sides.

This product has a fluorescent lamp that contains a small amount of mercury. Disposal of these materials may be regulated in your community due to environmental considerations.

For disposal or recycling information please contact your local authorities, or the Electronics Industries Alliance:

<<http://www.eiae.org>>

When the equipment is installed in a cabinet or on a shelf, make sure that it has sufficient space on all sides to allow for ventilation (10 cm (3-15/16") or more on both sides, on top and at the rear).

Do not block the ventilation holes.

(If the ventilation holes are blocked by a newspaper, or cloth etc. the heat may not be able to get out.)

No naked flame sources, such as lighted candles, should be placed on the apparatus.

When discarding batteries, environmental problems must be considered and the local rules or laws governing the disposal of these batteries must be followed strictly.

The apparatus shall not be exposed to dripping or splashing.

Do not use this equipment in a bathroom or places with water.

Also do not place any containers filled with water or liquids (such as cosmetics or medicines, flower vases, potted plants, cups etc.) on top of this unit.

(If water or liquid is allowed to enter this equipment, fire or electric shock may be caused.)

Do not point the lens or the viewfinder directly into the sun. This can cause eye injuries, as well as lead to the malfunctioning of internal circuitry. There is also a risk of fire or electric shock.

CAUTION!

The following notes concern possible physical damage to the camcorder and to the user.

Carrying or holding the camcorder by the viewfinder and/or the LCD monitor can result in dropping the unit, or in a malfunction.

Take care not to get your finger caught in the cassette holder cover. Do not let children operate the camcorder, as they are particularly susceptible to this type of injury.

Do not use a tripod on unsteady or unlevel surfaces. It could tip over, causing serious damage to the camcorder.

CAUTION!

Connecting cables (Audio/Video, S-Video, etc.) to the camcorder and leaving it on top of the TV is not recommended, as tripping on the cables will cause the camcorder to fall, resulting in damage.

IMPORTANT SAFETY INSTRUCTIONS

1. Read these instructions.
2. Keep these instructions.
3. Heed all warnings.
4. Follow all instructions.
5. Do not use this apparatus near water.
6. Clean only with dry cloth.
7. Do not block any ventilation openings. Install in accordance with the manufacturer's instructions.
8. Do not install near any heat sources such as radiators, heat registers, stoves, or other apparatus (including amplifiers) that produce heat.
9. Only use attachments/accessories specified by the manufacturer.
10. Use only with the cart, stand, tripod, bracket, or table specified by the manufacturer, or sold with the apparatus. When a cart is used, use caution when moving the cart/apparatus combination to avoid injury from tip-over.
11. Unplug this apparatus during lightning storms or when unused for long periods of time.
12. Refer all servicing to qualified service personnel. Servicing is required when the apparatus has been damaged in any way, such as power-supply cord or plug is damaged, liquid has been spilled or objects have fallen into the apparatus, the apparatus has been exposed to rain or moisture, does not operate normally, or has been dropped.



Before Using This Camcorder

Make sure you only use cassettes with the Mini DV mark ^{mini} DV.

Make sure you only use memory cards with the mark ^{SD} or MultiMediaCard.

This camcorder is designed exclusively for the digital video cassette, SD Memory Card and MultiMediaCard. Only cassettes marked "^{mini} DV" and memory cards marked "^{SD}" or "MultiMediaCard" can be used with this unit.

Remember that this camcorder is not compatible with other digital video formats.

Remember that this camcorder is intended for private consumer use only.

Any commercial use without proper permission is prohibited. (Even if you record an event such as a show, performance or exhibition for personal enjoyment, it is strongly recommended that you obtain permission beforehand.)

Before recording important video, be sure to make a trial recording.

Play back your trial recording to make sure the video and audio have been recorded properly.

We recommend cleaning your video heads before use.

If you haven't used your camcorder for awhile, the heads may be dirty. We recommend periodically cleaning the video heads with a cleaning cassette (optional).

Be sure to store your cassette tapes and camcorder in the proper environment.

Video heads can become dirty more easily if your cassette tapes and camcorder are stored in a dusty area. Cassette tapes should be removed from the camcorder and stored in cassette cases. Store the camcorder in a bag or other container.

Use SP (Standard) mode for important video recordings.

LP (Long Play) mode lets you record 50% more video than SP (Standard) mode, but you may experience mosaic-like noise during playback depending on the tape characteristics and the usage environment.

So, for important recordings, we recommend using SP mode.

It is recommended that you use JVC brand cassette tapes.

Your camcorder is compatible with all brands of commercially available cassette tapes complying with the MiniDV standard, but JVC brand cassette tapes are designed and optimized to maximize the performance of your camcorder.

Also read "CAUTIONS" on pages 49 and 50.

- Microsoft[®] and Windows[®] are either registered trademarks or trademarks of Microsoft Corporation in the United States and/or other countries.
- Macintosh is a registered trademark of Apple Computer, Inc.
- QuickTime is a registered trademark of Apple Computer, Inc.

GETTING STARTED	6	ADVANCED FEATURES	27
Index	6	MENUS FOR DETAILED ADJUSTMENT	27
Provided Accessories	9	Changing The Menu Settings	27
Power	11	Recording Menus	28
Operation Mode	12	Playback Menus	30
Date/Time Settings	12	FEATURES FOR RECORDING	31
Grip Adjustment	13	LED Light	31
Viewfinder Adjustment	13	Self-Timer	31
Brightness Adjustment Of The Display	13	5-Second Recording	32
Tripod Mounting	13	Night-Alive	32
Loading/Unloading A Cassette	14	Snapshot (For Video Recording)	32
Loading/Unloading A Memory Card	14	Manual Focus	32
		Exposure Control	33
VIDEO RECORDING & PLAYBACK	15	Iris Lock	33
VIDEO RECORDING	15	Backlight Compensation	33
Basic Recording	15	Spot Exposure Control	33
Tape Remaining Time	15	White Balance Adjustment	34
LCD Monitor And Viewfinder	15	Manual White Balance Adjustment	34
Zooming	16	Wipe Or Fader Effects	34
Journalistic Shooting	16	Program AE With Special Effects	35
Interface Shooting	16	Navigation Function	35
Time Code	17	EDITING	37
Recording From The Middle Of A Tape	17	Dubbing To Or From A VCR	37
VIDEO PLAYBACK	17	Dubbing To Or From A Video Unit Equipped With A DV Connector (Digital Dubbing)	38
Normal Playback	17	Connection To A Personal Computer	39
Still Playback	17	Audio Dubbing	40
Shuttle Search	18	Insert Editing	40
Blank Search	18	Random Assemble Editing [R.A.Edit]	41
Connections To A TV Or VCR	18		
Playback Using The Remote Control	19	REFERENCES	45
DIGITAL STILL CAMERA (D.S.C.) RECORDING & PLAYBACK	21	TROUBLESHOOTING	45
D.S.C. RECORDING	21	USER MAINTENANCE	48
Basic Shooting (D.S.C. Snapshot)	21	CAUTIONS	49
Interval Shooting	21	SPECIFICATIONS	51
D.S.C. PLAYBACK	22	TERMS	Back cover
Normal Playback Of Images	22		
Auto Playback Of Images	22		
Playback Of Video Clips	22		
Index Playback Of Files	23		
Viewing File Information	23		
Removing On-Screen Display	23		
ADDITIONAL FEATURES FOR D.S.C.	24		
E-Mail Clip Recording	24		
Dubbing Still Images Recorded On A Tape To A Memory Card	24		
Resetting The File Name	24		
Protecting Files	25		
Deleting Files	25		
Setting Print Information (DPOF Setting)	26		
Initializing A Memory Card	26		

Index

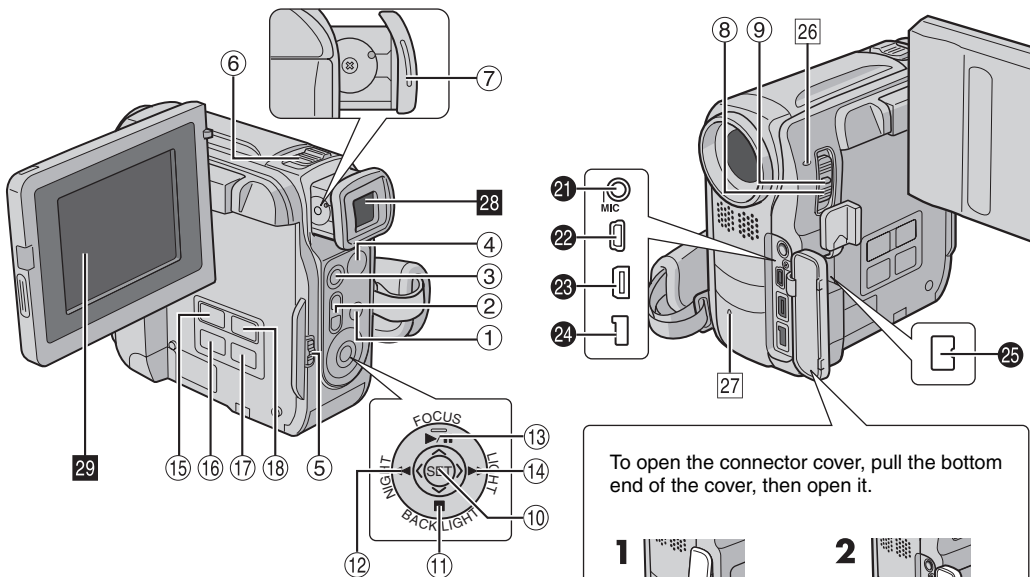

To open the connector cover, pull the bottom end of the cover, then open it.

1 Bottom end

2

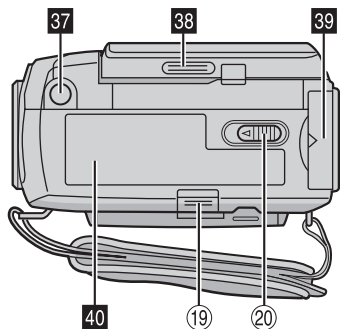
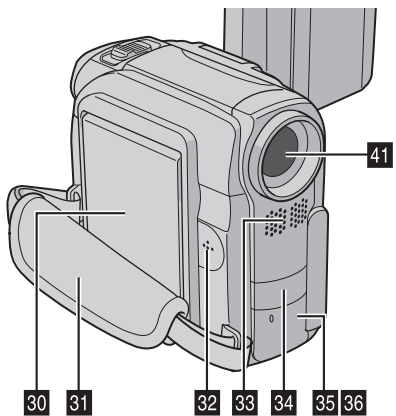

When Using the LCD Monitor

Correct direction for opening **Correct direction for closing**

The LCD monitor cannot be rotated downward (X direction) from the position illustrated above. Rotating to the wrong direction may cause a malfunction. Make sure to rotate to the correct direction.

ATTENTION:

- Be careful not to cover **33**, **36** and **41** during shooting.
- Be careful not to cover **32** during playback.

Controls

- ① Menu Button [MENU] (☞ pg. 27)
- ② Sub Zoom Buttons [T/W] (☞ pg. 16)
Speaker Volume Control [VOL. +, -] (☞ pg. 17)
- ③ Snapshot Button [SNAPSHOT] (☞ pg. 21, 32)
- ④ Recording Start/Stop Button (☞ pg. 15)
- ⑤ VIDEO/MEMORY Switch (☞ pg. 12)
- ⑥ Power Zoom Lever [T/W] (☞ pg. 16)
- ⑦ Diopter Adjustment Control (☞ pg. 13)
- ⑧ Power Switch [A, M, PLAY, OFF] (☞ pg. 12)
- ⑨ Lock Button (☞ pg. 12)
- ⑩ Set Button [SET] (☞ pg. 27)
- ⑪ Stop Button [■] (☞ pg. 17)
Backlight Compensation Button [BACK LIGHT] (☞ pg. 33)
Down Button [∨] (☞ pg. 27)
- ⑫ Rewind Button [◀◀] (☞ pg. 17)
Night Button [NIGHT] (☞ pg. 32)
Left Button [<] (☞ pg. 27)
- ⑬ Play/Pause Button [▶/⏸] (☞ pg. 17)
Manual Focus Button [FOCUS] (☞ pg. 32)
Up Button [^] (☞ pg. 27)
- ⑭ Fast-Forward Button [▶▶] (☞ pg. 17)
LED Light Button [LIGHT] (☞ pg. 31)
Right Button [>] (☞ pg. 27)
- ⑮ Information Button [INFO] (☞ pg. 23)
E-Mail Clip Recording Button [E-MAIL] (☞ pg. 24)
- ⑯ Index Button [INDEX] (☞ pg. 23)
Navigation Button [NAVI] (☞ pg. 36)
- ⑰ Thumbnail Storing Button [NAVI STORE] (☞ pg. 36)
- ⑱ D.S.C. Playback Select Button [SELECT] (☞ pg. 22, 23)
- ⑲ Battery Release Switch [BATT.RELEASE] (☞ pg. 11)
- ⑳ Cassette Open/Eject Switch [OPEN/EJECT] (☞ pg. 14)

Connectors

The connectors are located beneath the covers.

- ㉑ Microphone connector [MIC] (☞ pg. 30, 40)
(An optional microphone can be used during video recording and audio dubbing. To stabilize the microphone, use of an optional shoe adapter is recommended.)
- ㉒ USB (Universal Serial Bus) Connector (☞ pg. 39)
- ㉓ S-Video/Audio/Video Input/Output Connector [AV] (☞ pg. 18, 37, 42)
- ㉔ DC Input Connector [DC] (☞ pg. 11)
- ㉕ Digital Video Connector [DV IN/OUT] (i.Link*) (☞ pg. 38, 39)

* i.Link refers to the IEEE1394-1995 industry specification and extensions thereof. The  logo is used for products compliant with the i.Link standard.

Indicators

- ㉖ POWER/CHARGE Lamp (☞ pg. 11, 15)
- ㉗ Tally Lamp (☞ pg. 15, 29)

Other Parts

- ㉘ Viewfinder (☞ pg. 13)
- ㉙ LCD Monitor (☞ pg. 15, 16)
- ㉚ Battery Pack Mount (☞ pg. 11)
- ㉛ Grip Strap (☞ pg. 13)
- ㉜ Speaker (☞ pg. 17)
- ㉝ Stereo Microphone (☞ pg. 40)
(When using an optional conversion lens, it may cover this area. In this case, use of an optional microphone is recommended.)
- ㉞ LED Light (☞ pg. 31)
- ㉟ Remote Sensor (☞ pg. 19)
- ㊱ Camera Sensor
- ㊲ Tripod Mounting Socket (☞ pg. 13)
- ㊳ Monitor Open
- ㊴ Card Cover [MEMORY CARD] (☞ pg. 14)
- ㊵ Cassette Holder Cover (☞ pg. 14)
- ㊶ Lens

LCD Monitor/Viewfinder Indications

During Video Recording Only

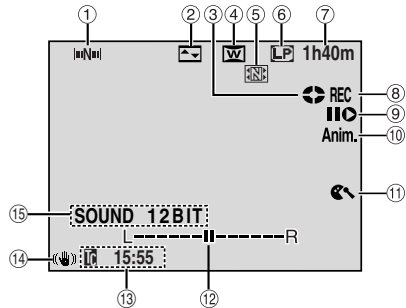

- ① Navigation Indicator (☞ pg. 35)
- ② Selected Wipe/Fader Effect Indicator (☞ pg. 34)
- ③ Tape Running Indicator (☞ pg. 15)
(The icon rotates during recording.)
- ④ Selected Wide Mode Indicator (☞ pg. 29)
- ⑤ Thumbnail Storing Indicator (☞ pg. 35)
- ⑥ Recording Speed Mode (SP/LP) (☞ pg. 28)
- ⑦ Tape Remaining Time (☞ pg. 15)
- ⑧ REC: (Appears during recording.) (☞ pg. 15)
PAUSE: (Appears during Record-Standby mode.) (☞ pg. 15)
- ⑨ Insert Editing/Insert Editing Pause Mode (☞ pg. 40)
- ⑩ 5S/Anim.: Displays the 5-Second Recording mode or Animation recording mode. (☞ pg. 28)
- ⑪ Wind Cut Indicator (☞ pg. 29)
- ⑫ Auxiliary Microphone Level Indicator
(Appears when an optional microphone is connected. ☞ pg. 30, "AUX MIC")
- ⑬ Time Code (☞ pg. 30, 31)
- ⑭ Digital Image Stabilizer ("DIS") (☞ pg. 28)
- ⑮ Sound Mode Indicator (☞ pg. 28)
(Appears for approx. 5 seconds after turning on the camcorder.)

During D.S.C. Recording Only

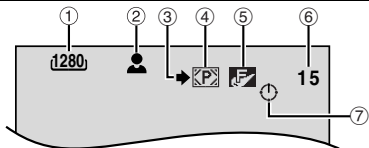

- ① Image Size: 1600 (1600 x 1200), 1280 (1280 x 960), 1024 (1024 x 768) or 640 (640 x 480) (↗ pg. 30)
- ② : Focus Icon (↗ pg. 21)
INTERVAL: Interval Shooting Icon (↗ pg. 21)
- ③ : Shooting Icon (↗ pg. 21)
(Appears and blinks during shooting.)
- ④ : Card Icon (↗ pg. 21)
: Appears during shooting.
: Blinks in white when a memory card is not loaded.
: Blinks in yellow while the camcorder is reading the data in the memory card such as Navigation thumbnail images, video clips, still images, etc.
- ⑤ : Picture Quality: (FINE) and (STANDARD) (in order of quality) (↗ pg. 30)
- ⑥ : Remaining Number Of Shots (↗ pg. 21)
(Displays the approximate remaining number of shots that can be stored during D.S.C. recording, or the remaining number of storable thumbnail images when it reaches 10 or less during video recording.)
- ⑦ : Clock Icon (↗ pg. 21)

During E-Mail Clip Recording

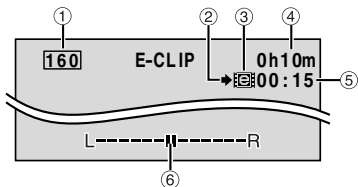

- ① Image Size: 160 (160 x 120)
- ② : Shooting Icon (↗ pg. 21, 24)
- ③ : E-Mail Clip Recording Indicator (↗ pg. 24)
- ④ : Memory Card Remaining Time For E-Mail Clip Recording (↗ pg. 24)
- ⑤ : E-Mail Clip Recording Time (↗ pg. 24)
- ⑥ : Auxiliary Microphone Level Indicator
(Appears when an optional microphone is connected.
↗ pg. 30, "AUX MIC")

During Both Video And D.S.C. Recording

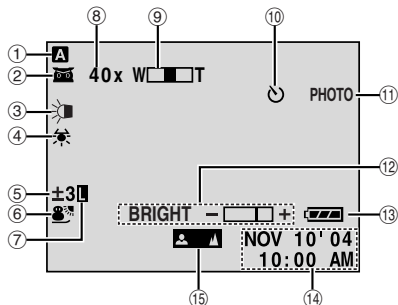

- ① : Operation Mode (↗ pg. 12)
- ② : Night-Alive Indicator (↗ pg. 32)
: Gain Up Mode (↗ pg. 28)
- ③ : LED Light Indicator (↗ pg. 31)
- ④ : White Balance Indicator (↗ pg. 34)
- ⑤ : Spot Exposure Control Indicator (↗ pg. 33)
: Backlight Compensation Indicator (↗ pg. 33)
: Exposure Adjustment Indicator (↗ pg. 33)
- ⑥ : Selected Program AE With Special Effects Indicator (↗ pg. 35)
- ⑦ : Iris Lock Indicator (↗ pg. 33)
- ⑧ : Approximate Zoom Ratio (↗ pg. 16)
- ⑨ : Zoom Indicator (↗ pg. 16)
- ⑩ : Self-Timer Recording Indicator (↗ pg. 31)
- ⑪ : PHOTO: (Appears when taking Snapshot.) (↗ pg. 32)
- ⑫ : Brightness Control Indicator (LCD monitor/Viewfinder) (↗ pg. 13)
- ⑬ : Battery Indicator (↗ pg. 47)
- ⑭ : Date/Time (↗ pg. 12)
- ⑮ : Manual Focus Adjustment Indicator (↗ pg. 32)

During Video Playback

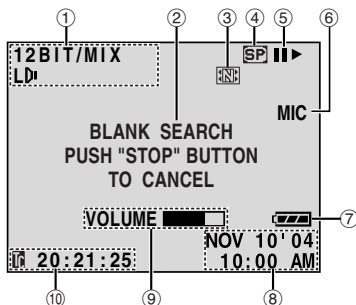

- ① Sound Mode Indicator (☞ pg. 30)
- ② Blank Search Indicator (☞ pg. 18)
- ③ Thumbnail Storing Indicator (☞ pg. 36)
- ④ Tape Speed (☞ pg. 28)
- ⑤ ▶ : Playback
 - ▶▶ : Fast-Forward/Shuttle Search
 - ◀◀ : Rewind/Shuttle Search
 - || : Pause
 - ||▶ : Forward Frame-By-Frame Playback/Slow-Motion
 - ◀|| : Reverse Frame-By-Frame Playback/Slow-Motion
 - : Audio Dubbing
 - ||● : Audio Dubbing Pause (Appear while a tape is running.)
- ⑥ Sound Input For Audio Dubbing (☞ pg. 40)
- ⑦ Battery Indicator (☞ pg. 47)
- ⑧ Date/Time (☞ pg. 29, 31)
- ⑨ VOLUME : Volume Level Indicator (☞ pg. 17)
- BRIGHT : Brightness Control Indicator (LCD monitor/Viewfinder) (☞ pg. 13)
- L-||-R : Auxiliary Microphone Level Indicator (Appears when an optional microphone is connected during Audio Dubbing. ☞ pg. 40)
- ⑩ Time Code (☞ pg. 30, 31)

During D.S.C. Playback

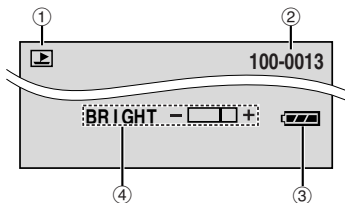

- ① Operation Mode Indicator (☞ pg. 23)
- ② Folder/File Number (☞ pg. 23)
- ③ Battery Indicator (☞ pg. 47)
- ④ Brightness Control Indicator (LCD monitor/Viewfinder) (☞ pg. 13)

Provided Accessories

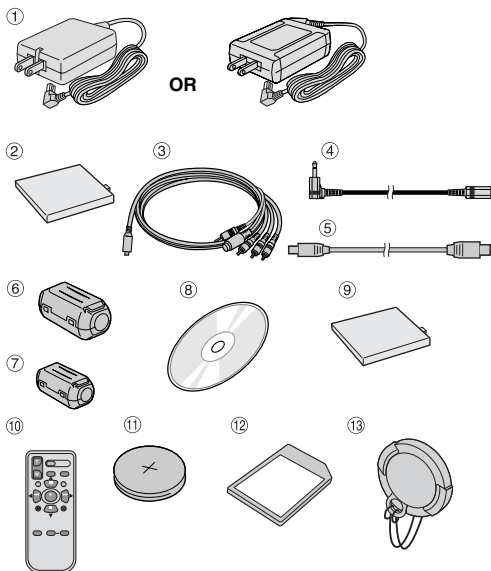

- ① AC Adapter AP-V14U (LY21103-009A) or AP-V15U (LY21154-003A)
- ② Battery Pack BN-V107U-S
- ③ S/AV/Editing Cable
- ④ Audio Extension Cable (for optional microphone, ☞ pg. 10 for connection)
- ⑤ USB Cable
- ⑥ Core Filter [large] (for USB Cable ☞ pg. 10 for attachment)
- ⑦ Core Filter [small] (for Audio Extension Cable ☞ pg. 10 for attachment)
- ⑧ CD-ROM
- ⑨ Battery Mount Cover* (Already attached on the camcorder)
- ⑩ Remote Control Unit RM-V720U
- ⑪ Lithium Battery CR2025** (for remote control unit)
- ⑫ Memory Card 8 MB (Already inserted in the camcorder)
- ⑬ Lens Cap (☞ pg. 10 for attachment)

* Attach the battery mount cover to protect the battery connector when the battery pack is removed. For the attachment/detachment, refer to "Charging The Battery Pack" (☞ pg. 11).

** A lithium battery is pre-installed in the Remote Control Unit at time of shipment (with insulation sheet). To use the Remote Control Unit, remove the insulation sheet.

NOTES:

- In order to maintain optimum performance of the camcorder, provided cables may be equipped with one or more core filter. If a cable has only one core filter, the end that is closest to the filter should be connected to the camcorder.
- Make sure to use the provided cables for connections. Do not use any other cables.

How To Attach The Lens Cap

To protect the lens, attach the provided lens cap to the camcorder as shown in the illustration.

NOTE:

To confirm the lens cap is on correctly make sure the cap is flush to the camcorder.

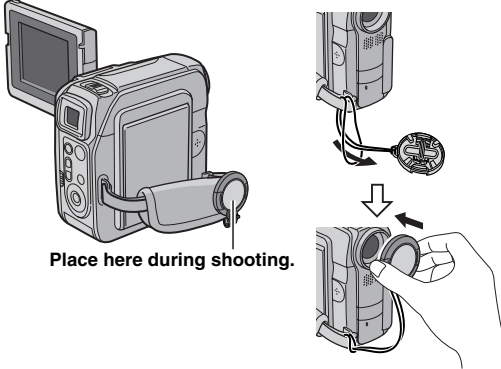

Place here during shooting.

How To Use The Audio Extension Cable

When using an optional external microphone, connect to the provided Audio extension cable (with a core filter attached), then connect the Audio extension cable to the camcorder. The core filter reduces interference. (See the right column.)

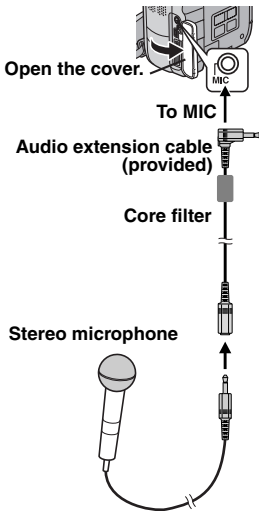

How To Attach The Core Filter (for USB Cable and Audio Extension Cable)

Attach the core filters to the cables. The core filter reduces interference.

1 Release the stoppers on both ends of the core filter.

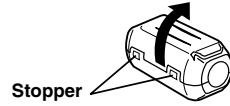

2 Run the cable through the core filter, leaving approx. 3 cm of cable between the cable plug and the core filter.

USB cable

Wind the cable once around the outside of the core filter as shown in the illustration.

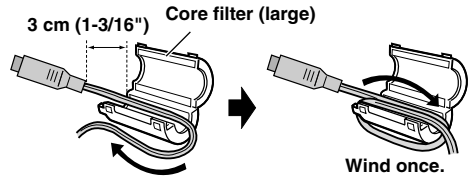

Audio Extension cable

Wind the cable twice around the outside of the core filter as shown in the illustration.

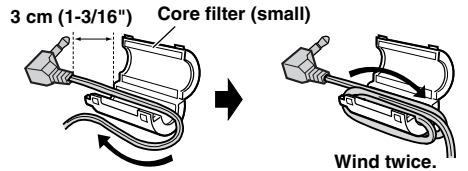

• Wind the cable so that it is not slack.

3 Close the core filter until it clicks shut.

USB cable

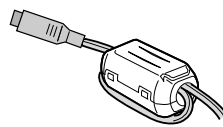

Audio Extension cable

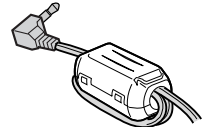

NOTES:

- Take care not to damage the cable.
- When connecting a cable, attach the end with the core filter to the camcorder.

Power

This camcorder's 2-way power supply system lets you choose the most appropriate source of power. Do not use provided power supply units with other equipment.

Charging The Battery Pack

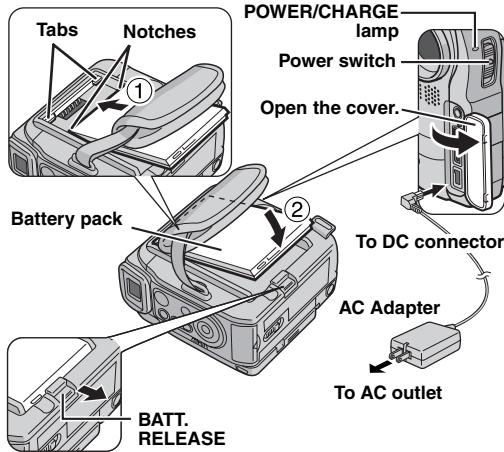

- 1 Set the Power Switch to "OFF".
- 2 Align the battery pack's two notches with the tabs on the camcorder's battery pack mount.
- 3 Insert the terminal end ① of the battery pack into the battery pack mount.
- 4 Firmly push the end ② of the battery pack until it locks into place.
- 5 Connect the AC Adapter to the camcorder.
- 6 Plug the AC Adapter into an AC outlet. The POWER/CHARGE lamp on the camcorder blinks to indicate charging has started.
- 7 When the POWER/CHARGE lamp goes out, charging is finished. Unplug the AC Adapter from the AC outlet. Disconnect the AC Adapter from the camcorder.

To detach the battery pack

While sliding **BATT. RELEASE**, remove the battery pack.

Battery pack	Charging time
BN-V107U*	Approx. 1 hr. 30 min.
BN-V114U	Approx. 3 hr.

* Provided

NOTES:

- It is recommended that only genuine JVC batteries are used in this camcorder. Using generic non-JVC batteries can cause damage to the internal charging circuitry.
- If the protective cap is attached to the battery pack, remove it first.
- During charging, the camcorder cannot be operated.
- Charging is not possible if the wrong type of battery is used.

- When charging the battery pack for the first time or after a long storage period, the POWER/CHARGE lamp may not light. In this case, remove the battery pack from the camcorder, then try charging again.
- If the battery operation time remains extremely short even after having been fully charged, the battery is worn out and needs to be replaced. Please purchase a new one.
- Since the AC Adapter processes electricity internally, it becomes warm during use. Be sure to use it only in well-ventilated areas.
- Using the optional AA-V100 AC Power Adapter/Charger, you can charge the BN-V107U/V114U battery pack without the camcorder. However, it cannot be used as an AC Adapter.
- After 5 minutes has elapsed in Record-Standby mode with the cassette inserted, the camcorder will automatically turn off its power supplied from the AC adapter. In this case, the battery charge starts if the battery is attached to the camcorder.

Using The Battery Pack

Perform steps **2 – 4** in "Charging The Battery Pack".

Maximum continuous recording time

Battery pack	LCD monitor on	Viewfinder on
BN-V107U*	1 hr. 10 min.	1 hr. 30 min.
BN-V114U	2 hr. 25 min.	3 hr.

* Provided

NOTES:

- Recording time is reduced significantly under the following conditions:
 - Zoom or Record-Standby mode is engaged repeatedly.
 - The LCD monitor is used repeatedly.
 - The playback mode is engaged repeatedly.
 - The LED Light is used.
- Before extended use, it is recommended that you prepare enough battery packs to cover 3 times the planned shooting time.

ATTENTION:

Before detaching the power source, make sure that the camcorder's power is turned off. Failure to do so can result in a camcorder malfunction.

Using AC Power

Connect the AC Adapter to the camcorder as shown in the illustration.

NOTE:

The provided AC Adapter features automatic voltage selection in the AC range from 110 V to 240 V.

About Batteries

DANGER! Do not attempt to take the batteries apart, or expose them to flame or excessive heat, as it may cause a fire or explosion.

WARNING! Do not allow the battery or its terminals to come in contact with metals, as this can result in a short circuit and possibly start a fire.

The Benefits Of Lithium-Ion Batteries

Lithium-ion battery packs are small but have a large power capacity. However, when one is exposed to cold temperatures (below 10°C/50°F), its usage time becomes shorter and it may cease to function. If this happens, place the battery pack in your pocket or other warm, protected place for a short time, then re-attach it to the camcorder.

Operation Mode

To turn on the camcorder, set the Power Switch to any operation mode except "OFF" while pressing down the Lock Button located on the switch.

POWER/CHARGE lamp

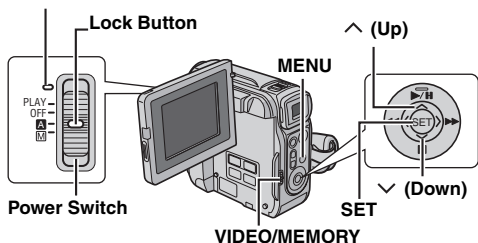

Choose the appropriate operation mode according to your preference using the Power Switch and **VIDEO/MEMORY** Switch.

Power Switch Position	
A (Full Auto Recording):	Allows you to record using NO special effects or manual adjustments. Suitable for standard recording. The "A" indicator appears on the display.
M (Manual Recording):	Allows you to set various recording functions using the Menus. (pg. 27) If you want more creative capabilities than Full Auto Recording, try this mode.
OFF:	Allows you to switch off the camcorder.
PLAY:	<ul style="list-style-type: none"> Allows you to play back a recording on the tape. Allows you to play back a video clip on the memory card. Allows you to display a still image stored in the memory card or to transfer a still image stored in the memory card to a PC. Allows you to set various playback functions using the Menus. (pg. 27)

VIDEO/MEMORY Switch Position
<p>VIDEO: Allows you to record on a tape or play back a tape. If "REC SELECT" is set to "▶▶▶/▶▶▶" (pg. 30), still images are recorded both on the tape and the memory card.</p> <p>MEMORY:</p> <ul style="list-style-type: none"> Allows you to record in a memory card or access data stored in a memory card. When the Power Switch is set to "A" or "M", the currently selected image size appears.

Power-Linked Operation

When the Power Switch is set to "A" or "M", you can also turn on/off the camcorder by opening/closing the LCD monitor or pulling out/pushing in the viewfinder.

INFORMATION:

The following explanations in this manual suppose the use of LCD monitor in your operation. If you want to use the viewfinder, close the LCD monitor and pull out the viewfinder fully.

Date/Time Settings

The date/time is recorded onto the tape at all times, but its display can be turned on or off during playback. (pg. 27, 31)

- Set the Power Switch to "M" while pressing down the Lock Button located on the switch.
- Open the LCD monitor fully. (pg. 15)
- Press **MENU**. The Menu Screen appears.
- Press **^** or **v** to select "C", and press **SET**. The CAMERA DISPLAY Menu appears.
- Press **^** or **v** to select "CLOCK ADJ.", and press **SET**. The parameter for "Month" is highlighted.
- Press **^** or **v** to input the month, and press **SET**. Repeat to input the day, year, hour and minute.
- Press **^** or **v** to select "RETURN", and press **SET** twice. The Menu Screen closes.

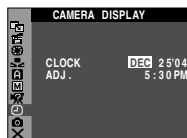
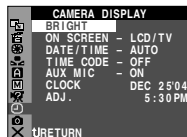

Built-in Clock's Rechargeable Lithium Battery

If the camcorder is not used for approx. 3 months, the clock's lithium battery will become discharged and the date/time stored in memory will be lost. When this occurs, first connect the camcorder to an AC outlet using the AC Adapter for over 24 hours to charge the clock's rechargeable lithium battery. Then perform the date/time setting before using the camcorder.

Note that the camcorder can be used without setting the date/time.

Grip Adjustment

- 1 Adjust the velcro strip.
- 2 Pass your right hand through the loop and grasp the grip.
- 3 Adjust your thumb and fingers through the grip to easily operate the Recording Start/Stop Button and Power Zoom Lever. Be sure to fasten the velcro strip to your preference.

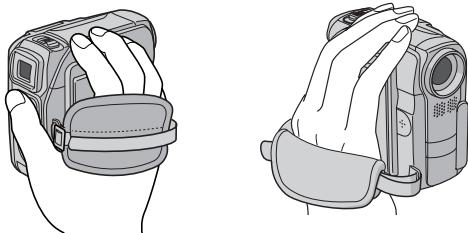

Viewfinder Adjustment

- 1 Set the Power Switch to "A" or "M" while pressing down the Lock Button located on the switch.
- 2 Make sure the LCD monitor is closed and locked. Pull out the viewfinder fully and adjust it manually for best viewability.
- 3 Turn the Diopter Adjustment Control until the indications in the viewfinder are clearly focused.

Example:

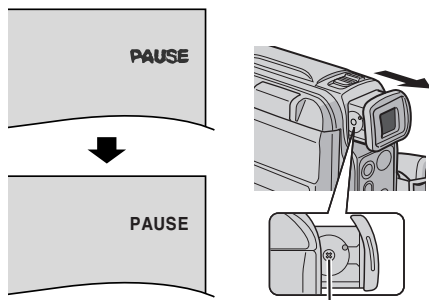

Diopter Adjustment Control

CAUTION:

When retracting the viewfinder, take care not to pinch your fingers.

Brightness Adjustment Of The Display

- 1 Set the Power Switch to "M" or "PLAY" while pressing down the Lock Button located on the switch.
- 2 Open the LCD monitor fully. (pg. 15)
 - To adjust the brightness of the viewfinder, pull out the viewfinder fully and set "PRIORITY" to "FINDER" (pg. 27, 29).
- 3 Press **MENU**. The Menu Screen appears.
- 4 Press **^** or **v** to select "CAM", and press **SET**. The CAMERA DISPLAY Menu appears.
- 5 Press **^** or **v** to select "BRIGHT", and press **SET**. The Menu Screen closes and the brightness control indicator appears.
- 6 Press **<** or **>** until the appropriate brightness is reached.
- 7 Press **SET** to clear the brightness control indicator from the display.

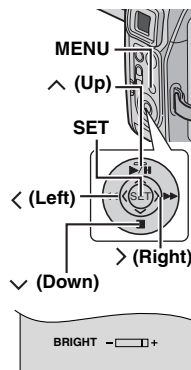

GETTING STARTED

Tripod Mounting

To attach the camcorder to a tripod, align screw to the mounting socket on the camcorder. Then tighten the screw clockwise.

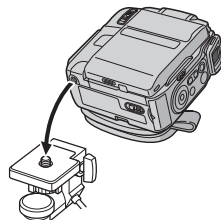

Loading/Unloading A Cassette

The camcorder needs to be powered up to load or eject a cassette.

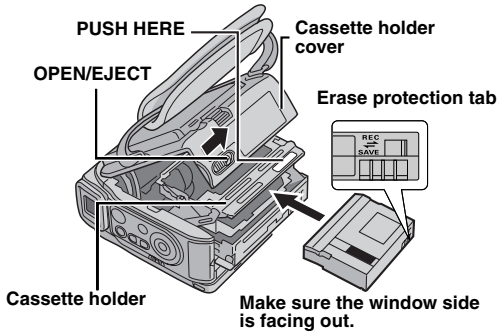

1 Slide and hold **OPEN/EJECT** in the direction of the arrow, then pull the cassette holder cover open until it locks. The cassette holder opens automatically.

- Do not touch internal components.

2 Insert or remove a tape and press “PUSH HERE” to close the cassette holder.

- Be sure to press only the section labeled “PUSH HERE” to close the cassette holder; touching other parts may cause your finger to get caught in the cassette holder, resulting in injury or product damage.

- Once the cassette holder is closed, it recedes automatically. Wait until it recedes completely before closing the cassette holder cover.
- When the battery pack’s charge is low, you may not be able to close the cassette holder cover. Do not apply force. Replace the battery pack with a fully charged one or use AC power before continuing.

3 Close the cassette holder cover firmly until it locks into place.

To protect valuable recordings

Slide the erase protection tab on the back of the tape in the direction of “SAVE”. This prevents the tape from being recorded over. To record on this tape, slide the tab back to “REC” before loading it.

NOTES:

- If you wait a few seconds and the cassette holder does not open, close the cassette holder cover and try again. If the cassette holder still does not open, turn the camcorder off then on again.
- If the tape does not load properly, open the cassette holder cover fully and remove the cassette. A few minutes later, insert it again.
- When the camcorder is suddenly moved from a cold place to a warm environment, wait a short time before opening the cassette holder cover.

Loading/Unloading A Memory Card

The provided memory card is already inserted in the camcorder at the time of purchase.

Card Cover (MEMORY CARD)

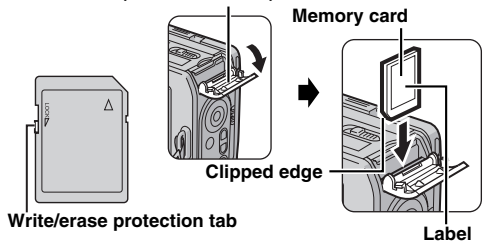

1 Make sure the camcorder’s power is off.

2 Open the card cover (MEMORY CARD).

3 To load a memory card, firmly insert it with its clipped edge first.

To unload a memory card, push it once. After the memory card comes out of the camcorder, pull it out.

- Do not touch the terminal on the reverse side of the label.

4 Close the card cover.

To protect valuable files (available only for SD Memory Card)

Slide the write/erase protection tab on the side of the memory card in the direction of “LOCK”. This prevents the memory card from being recorded over. To record on this memory card, slide the tab back to the position opposite to “LOCK” before loading it.

NOTES:

- Some brands of memory cards are not compatible with this camcorder. Before purchasing a memory card, consult its manufacturer or dealer.
- Before using a new memory card, it is necessary to format the card. (▶ pg. 26)

ATTENTION:

Do not insert or remove the memory card while the camcorder is turned on, as this may cause the memory card to be corrupted or cause the camcorder to become unable to recognize whether or not the card is installed.

Basic Recording

NOTE:

Before continuing, perform the procedures listed below:

- Power (☞ pg. 11)
- Loading A Cassette (☞ pg. 14)

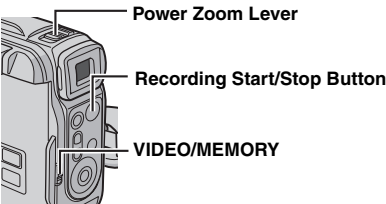
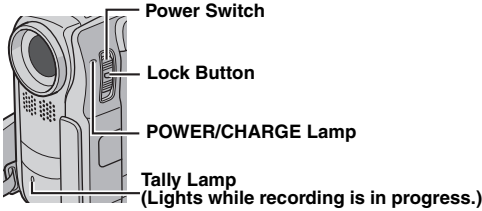

- 1 Remove the lens cap. (☞ pg. 10)
- 2 Open the LCD monitor fully.
- 3 Set the **VIDEO/MEMORY** Switch to "VIDEO".
- 4 Set the Power Switch to "A" or "M" while pressing down the Lock Button located on the switch.
 - The POWER/CHARGE lamp lights and the camcorder enters the Record-Standby mode. "PAUSE" is displayed.
 - To record in LP (Long Play) mode, ☞ pg. 27, 28.
- 5 To start recording, press the Recording Start/Stop Button. The tally lamp lights and "REC" appears on the display while recording is in progress.
- 6 To stop recording, press the Recording Start/Stop Button again. The camcorder re-enters the Record-Standby mode.

Approximate recording time

Tape	Recording mode	
	SP	LP
30 min.	30 min.	45 min.
60 min.	60 min.	90 min.
80 min.	80 min.	120 min.

NOTES:

- If the Record-Standby mode continues for 5 minutes, the camcorder's power shuts off automatically. To turn the camcorder on again, push back and pull out the viewfinder again or close and re-open the LCD monitor.
- When a blank portion is left between recorded scenes on the tape, the time code is interrupted and errors may occur when editing the tape. To avoid this, refer to "Recording From The Middle Of A Tape" (☞ pg. 17).
- To turn the tally lamp or beep sounds off, ☞ pg. 27, 29.

Tape Remaining Time

Approximate tape remaining time appears on the display. "- h - - m" means the camcorder is calculating the remaining time. When the remaining time reaches 2 minutes, the indication starts blinking.

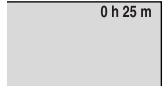

- The time required to calculate and display the remaining tape length, and the accuracy of the calculation, may vary according to the type of tape used.

LCD Monitor And Viewfinder

While using the LCD monitor:

Make sure the viewfinder is pushed back in. Pull on the bottom end of the LCD monitor to open it. It can rotate 270° (90° downward, 180° upward).

While using the viewfinder:

Make sure the LCD monitor is closed and locked. Pull out the viewfinder fully.

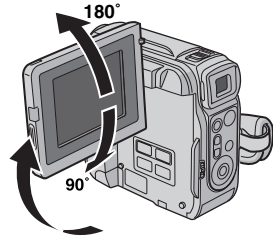

NOTES:

- The image will not appear simultaneously on the LCD monitor and the viewfinder except during Interface Shooting. (☞ pg. 16) When the viewfinder is pulled out while the LCD monitor is opened, you can select which one to use. Set "PRIORITY" to the desired mode in SYSTEM Menu. (☞ pg. 27, 29)
- Colored bright spots may appear all over the LCD monitor or the viewfinder. However, this is not a malfunction. (☞ pg. 46)

Zooming

Produces the zoom in/out effect, or an instantaneous change in image magnification.

Zoom In

Slide the Power Zoom Lever towards "T" (or press Sub Zoom Button T).

Zoom Out

Slide the Power Zoom Lever towards "W" (or press Sub Zoom Button W).

The further you slide the Power Zoom Lever, the quicker the zoom action.

Zoom in (T: Telephoto)

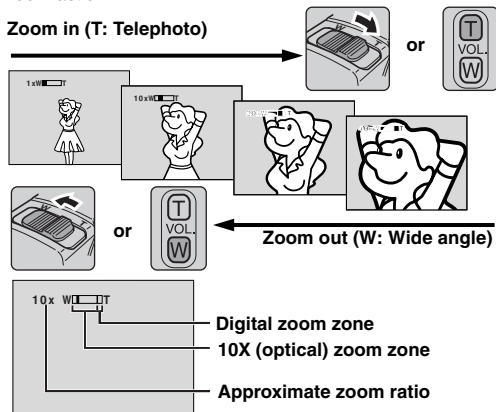

Sub Zooming buttons

When you hold the camcorder as illustrated, pressing the Sub Zoom Buttons (instead of sliding the Power Zoom Lever) is more easy to operate Zooming function.

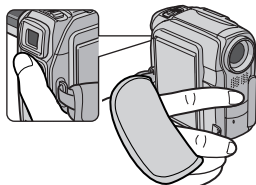

NOTES:

- Focusing may become unstable during Zooming. In this case, set the zoom while in Record-Standby, lock the focus by using the manual focus (☞ pg. 32), then zoom in or out in Record mode.
- Zooming is possible to a maximum of 500X, or it can be switched to 10X magnification using the optical zoom. (☞ pg. 28)
- Zoom magnification of over 10X is done through Digital image processing, and is therefore called Digital Zoom.
- During Digital zoom, the quality of image may suffer.
- Zooming is possible to a maximum of 10X regardless of the "ZOOM" setting (☞ pg. 28) when the VIDEO/MEMORY Switch is set to "MEMORY".
- Macro shooting (as close as approx. 5 cm (2") to the subject) is possible when the Power Zoom Lever is set all the way to "W". Also see "TELE MACRO" in MANUAL Menu on page 28.
- When shooting a subject close to the lens, zoom out first. If zoomed-in in the auto focus mode, the camcorder may automatically zoom out depending on the distance between the camcorder and the subject. This will not occur when "TELE MACRO" is set to "ON". (☞ pg. 28)

Journalistic Shooting

In some situations, different shooting angles may provide more dramatic results. Hold the camcorder in the desired position and tilt the LCD monitor in the most convenient direction. It can rotate 270° (90° downward, 180° upward).

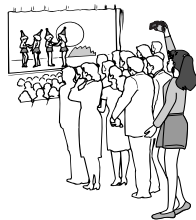

Interface Shooting

The person you shoot can view himself/herself in the LCD monitor, and you can even shoot yourself while viewing your own image in the LCD monitor.

1) Open the LCD monitor and tilt it upward to 180° so that it faces forward.

2) Point the lens toward the subject (yourself when self-recording) and start recording.

- During Interface Shooting, the monitor image appears inverted as it would when viewing a mirror. However, the actual recorded image does not appear inverted.
- During Interface Shooting, the "Tape Running" indicator and warning indications (☞ pg. 47, 48) are the only ones that are shown; they appear reversed in the display as they would when viewing a mirror, but are not reversed in the recording.
- The tape remaining indicator does not appear during interface shooting. However, when the remaining time reaches 2 minutes, the indicator appears showing the remaining time:
 - ▶ (blinking)
 - ▶ (blinking)
 - ▶ (blinking)



Time Code

During recording, a time code is recorded on the tape. This code is to confirm the location of the recorded scene on the tape during playback.

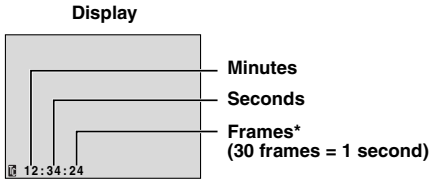

* Frames are not displayed during recording.

If recording starts from a blank portion of the tape, the time code begins counting from "00:00:00" (minute:second:frame). If recording starts from the end of a previously recorded scene, the time code continues from the last time code number.

To perform Random Assemble Editing (☞ pg. 41 – 44), time code is necessary. If during recording a blank portion is left partway through the tape, the time code is interrupted. When recording is resumed, the time code starts counting up again from "00:00:00". This means the camcorder may record the same time codes as those existing in a previously recorded scene. To prevent this, perform "Recording From The Middle Of A Tape" (see below) in the following cases;

- When shooting again after playing back a recorded tape.
- When power shuts off during shooting.
- When a tape is removed and re-inserted during shooting.
- When shooting using a partially recorded tape.
- When shooting on a blank portion located partway through the tape.
- When shooting again after shooting a scene then opening/closing the cassette holder cover.

NOTES:

- The time code cannot be reset.
- During fast-forwarding and rewinding, the time code indication does not move smoothly.
- The time code is displayed only when "TIME CODE" is set to "ON". (☞ pg. 30)

Recording From The Middle Of A Tape

- 1) Play back a tape or use Blank Search (☞ pg. 18) to find the spot at which you want to start recording, then engage the Still Playback mode. (☞ pg. 17)
- 2) Set the Power Switch to "A" or "M" while pressing down the Lock Button located on the switch, then start recording.

Normal Playback

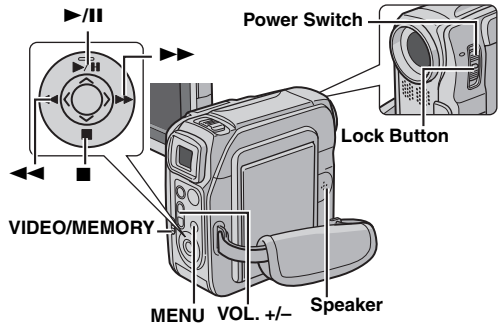

- 1 Load a cassette. (☞ pg. 14)
- 2 Set the **VIDEO/MEMORY** Switch to "VIDEO".
- 3 Set the Power Switch to "PLAY" while pressing down the Lock Button located on the switch.
- 4 To start playback, press **▶/||**.
- 5 To stop playback, press **■**.
 - During Stop mode, press **◀◀** to rewind, or **▶▶** to fast-forward the tape.

To control the speaker volume

Press **VOL. +** to turn up the volume, or **VOL. -** to turn down the volume.

NOTES:

- The playback picture can be viewed in the LCD monitor, viewfinder or on a connected TV. (☞ pg. 18)
- If Stop mode continues for 5 minutes when power is supplied from a battery, the camcorder shuts off automatically. To turn on again, set the Power Switch to "OFF", then to "PLAY".
- When a cable is connected to the AV connector, the sound is not heard from the speaker.

Still Playback

Pauses during video playback.

- 1) Press **▶/||** during playback.
- 2) To resume normal playback, press **▶/||** again.
 - If still playback continues for more than about 3 minutes, the camcorder's Stop mode is automatically engaged.

Shuttle Search

Allows high-speed search in either direction during video playback.

- 1) During playback, press ►► for forward search, or ◀◀ for reverse search.
- 2) To resume normal playback, press ►/||.
- During playback, press and hold ►► or ◀◀. The search continues as long as you hold the button. Once you release the button, normal playback resumes.
- A slight mosaic effect appears on the display during Shuttle Search. This is not a malfunction.

ATTENTION:

During Shuttle Search, parts of the picture may not be clearly visible, particularly on the left side of the screen.



Blank Search

Helps you find where you should start recording in the middle of a tape to avoid time code interruption.

(☞ pg. 17)

- 1 Load a cassette. (☞ pg. 14)
- 2 Set the VIDEO/MEMORY Switch to "VIDEO".
- 3 Set the Power Switch to "PLAY" while pressing down the Lock Button located on the switch.
- 4 Press MENU. The Menu Screen appears.
- 5 Press SET to select "☐". The VIDEO Menu appears.
- 6 Press ^ or v to select "BLANK SRCH", and press SET. The Sub Menu appears.
- 7 Press ^ or v to select "EXECUTE", and press SET.
 - The "BLANK SEARCH" indication appears and the camcorder automatically starts reverse or forward search, then stops at the spot which is about 3 seconds of tape before the beginning of the detected blank portion.
 - To cancel Blank Search midway, press ■.

NOTES:

- Before starting Blank Search, if the current position is at a blank portion, the camcorder searches in the reverse direction. If the current position is at a recorded portion, the camcorder searches in the forward direction.
- If the beginning or end of the tape is reached during Blank Search, the camcorder stops automatically.
- A blank portion which is shorter than 5 seconds of tape may not be detected.
- The detected blank portion may be located between recorded scenes. Before you start recording, make sure there is no recorded scene after the blank portion.

Connections To A TV Or VCR

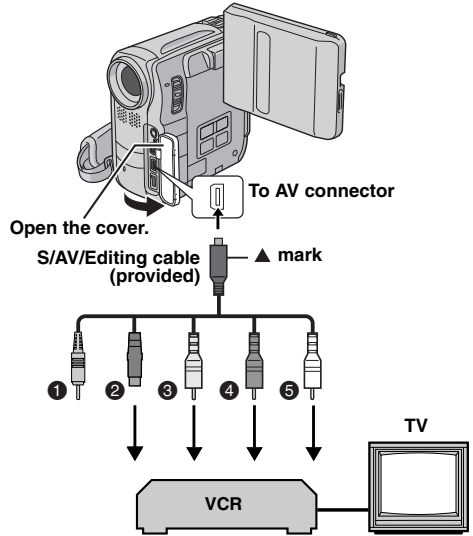

- 1 Remote plug: Not connected (When not in use, keep the Remote plug in its protective caddy.)
 - 2 Black to S-VIDEO IN (Connect when your TV/VCR has S-VIDEO IN and A/V input connectors. In this case, it is not necessary to connect the yellow video cable.)
 - 3 Yellow to VIDEO IN (Connect when your TV/VCR has only A/V input connectors.)
 - 4 Red to AUDIO R IN*
 - 5 White to AUDIO L IN*
- * Not required for watching still images only.

- 1 Make sure all units are turned off.
- 2 Connect the camcorder to a TV or VCR as shown in the illustration.
- If using a VCR, go to step 3. If not, go to step 4.**
- 3 Connect the VCR output to the TV input, referring to your VCR's instruction manual.
- 4 Turn on the camcorder, the VCR and the TV.
- 5 Set the VCR to its AUX input mode, and set the TV to its VIDEO mode.
- 6 Start playback on the camcorder. (☞ pg. 17)

To choose whether or not the following displays appear on the connected TV

- Date/Time
Set "DATE/TIME" to "AUTO", "ON" or "OFF". (☞ pg. 27, 31)
Or, press DISPLAY on the remote control to turn on/off the date indication.
- Time Code
Set "TIME CODE" to "ON" or "OFF". (☞ pg. 27, 31)
- Indications other than date/time and time code
Set "ON SCREEN" to "OFF", "LCD" or "LCD/TV".
(☞ pg. 27, 31)

NOTES:

- It is recommended to use the AC Adapter as the power supply instead of the battery pack. (☞ pg. 11)
- To monitor the picture and sound from the camcorder without inserting a tape or memory card, set the camcorder's Power Switch to "A" or "M", then set your TV to the appropriate input mode.
- Make sure you adjust the TV sound volume to its minimum level to avoid a sudden burst of sound when the camcorder is turned on.

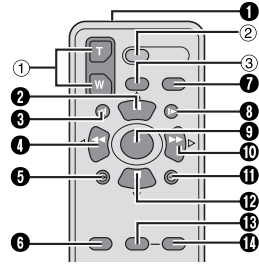
Buttons And Functions

- ① Infrared beam transmitting window
 • Transmits the beam signal.

The following buttons are available only when the camcorder's Power Switch is set to "PLAY".

- ② PAUSE Button
 • Pauses the tape (☞ pg. 20)
 Up Button (☞ pg. 20)
- ③ SLOW Rewind Button (☞ pg. 20)
- ④ REW Button
 • Rewind/Reverse Shuttle Search on a tape (☞ pg. 18)
 • Displays previous file in a memory card (☞ pg. 22)
 Left Button (☞ pg. 20)
- ⑤ INSERT Button (☞ pg. 40)
- ⑥ SHIFT Button (☞ pg. 20, 41)
- ⑦ DISPLAY Button (☞ pg. 18, 37, 42)
- ⑧ SLOW Forward Button (☞ pg. 20)
- ⑨ PLAY Button
 • Starts Playback of a tape (☞ pg. 17)
 • Starts Auto Playback of images in a memory card (☞ pg. 22)
- ⑩ FF Button
 • Forward/Forward Shuttle Search on a tape (☞ pg. 18)
 • Displays next file in a memory card (☞ pg. 22)
 Right Button (☞ pg. 20)
- ⑪ A. DUB Button (☞ pg. 40)
- ⑫ STOP Button
 • Stops the tape (☞ pg. 17)
 • Stops Auto Playback (☞ pg. 22)
 Down Button (☞ pg. 20)
- ⑬ EFFECT Button (☞ pg. 20)
- ⑭ EFFECT ON/OFF Button (☞ pg. 20)

The following buttons are available when the camcorder's Power Switch is set to "A" or "M".

- ① Zoom (T/W) Buttons
 Zoom in/out (☞ pg. 16, 20)
 (Also available with the Power Switch set to "PLAY")
- ② START/STOP Button
 Functions the same as the Recording Start/Stop Button on the camcorder.
- ③ S.SHOT Button
 Functions the same as **SNAPSHOT** on the camcorder.
 (Also available with the Power Switch set to "PLAY")

Playback Using The Remote Control

The Full-Function Remote Control Unit can operate this camcorder from a distance as well as the basic operations (Playback, Stop, Pause, Fast-Forward and Rewind) of your VCR. It also makes additional playback functions possible. (☞ pg. 20)

Installing The Battery

The remote control uses one lithium battery (CR2025).

- 1 Pull out the battery holder by pushing the lock tab.
- 2 Insert the battery in the holder, and be sure to have the "+" mark visible.
- 3 Slide the holder back in until you hear a click.

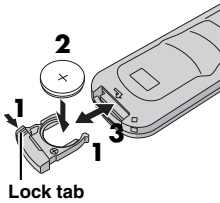
**Beam Effective Area (indoor use)**

When using the remote control, be sure to point it at the remote sensor. The transmitted beam's approximate effective distance for indoor use is 5 m (16 ft).

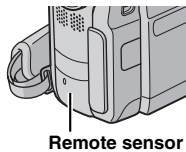
**NOTE:**

The transmitted beam may not be effective or may cause incorrect operation when the remote sensor is directly exposed to sunlight or powerful lighting.

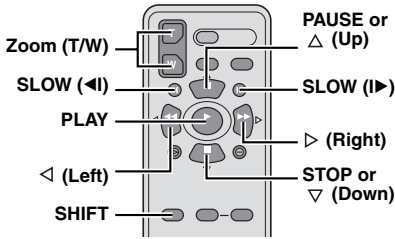

Slow-Motion Playback

During normal video playback, press **SLOW** (◀| or |▶) more than approx. 2 seconds.

- After approx. 10 minutes, normal playback resumes.
- To pause Slow-Motion playback, press **PAUSE** (II).
- To stop Slow-Motion playback, press **PLAY** (▶).

NOTES:

- You can also engage Slow-Motion Playback from Still Playback by pressing **SLOW** (◀| or |▶) more than approx. 2 seconds.
- During Slow-Motion Playback, due to digital image processing, the picture may take on a mosaic effect.
- After **SLOW** (◀| or |▶) is pressed and held, the still image may be displayed for a few seconds, followed by a blue screen for a few seconds. This is not a malfunction.
- During Slow-Motion Playback, there will be disturbances in video and the picture may seem unstable, especially with steady images. This is not a malfunction.

Frame-By-Frame Playback

During normal or still playback, press **SLOW** (|▶) repeatedly for forward or **SLOW** (◀|) repeatedly for reverse. Each time **SLOW** (◀| or |▶) is pressed, the frame is played back.

Playback Zoom

Magnifies the recorded image up to 50X at any time during video playback and D.S.C. playback.

1) Press **PLAY** (▶) to start video playback. Or perform normal playback of images.



2) At the point you want to zoom in, press the Zoom Button (T).

- To zoom out, press the Zoom Button (W).



3) You can move the image on the screen around to find a particular portion of the picture. While holding down **SHIFT**, press ◀ (Left), ▶ (Right), Δ (Up) and ▽ (Down).



- To end zoom, press and hold **W** until magnification returns to normal. Or, press **STOP** (■) and then press **PLAY** (▶) during video playback.

NOTES:

- Zoom can also be used during slow-motion and still playback.
- Due to digital image processing, the quality of the image may suffer.

Playback Special Effects

Allows you to add creative effects to the video playback image.

CLASSIC FILM: Gives recorded scenes a strobe effect.

B/W MONOTONE: Like classic black and white films, your footage is shot in B/W. Used together with the Cinema mode, it enhances the "classic film" effect.

SEPIA: Recorded scenes have a brownish tint like old photos. Combine this with the Cinema mode for a classic look.

STROBE: Your recording looks like a series of consecutive snapshots.

1) To start playback, press **PLAY** (▶).

2) Press **EFFECT**.

The **PLAYBACK EFFECT Select Menu** appears.

3) Press **EFFECT**

repeatedly to move the highlight bar to the desired effect.

- The selected function is activated and after 2 seconds the menu disappears.

- To deactivate the selected effect, press **EFFECT ON/OFF**. To reactivate the selected effect press **EFFECT ON/OFF** again.

- To change the selected effect, repeat from step 2 above.

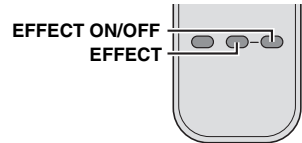

Basic Shooting (D.S.C. Snapshot)

You can use your camcorder as a Digital Still Camera for taking snapshots. Still images are stored in the memory card.

NOTE:

Before continuing, perform the procedures listed below:

- Power (⇨ pg. 11)
- Loading a Memory Card (⇨ pg. 14)

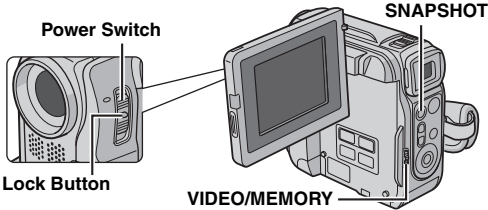

- 1 Remove the lens cap.
- 2 Open the LCD monitor fully. (⇨ pg. 15)
- 3 Set the **VIDEO/MEMORY** Switch to "MEMORY".
- 4 Set the Power Switch to "A" or "M" while pressing down the Lock Button located on the switch.
 - To change the Image Size and/or Picture Quality, ⇨ pg. 27, 30.
- 5 Press **SNAPSHOT**. The "PHOTO" indication appears while the snapshot is being taken.
 - To check how the image looks before recording it in the memory card, press **SNAPSHOT** halfway and hold. The "A" indicator appears and stops blinking when the captured image is focused. To cancel the recording, release **SNAPSHOT**. To record it in the memory card, press **SNAPSHOT** fully.
 - Still images are recorded in the snapshot mode with no frame.
 - To delete unwanted still images, refer to "Deleting Files" (⇨ pg. 25).
 - When you do not want to hear the shutter sound, set "BEEP" to "OFF". (⇨ pg. 27, 29)

NOTE:

If shooting is not performed for approx. 5 minutes when the Power Switch is set to "A" or "M" and power is supplied from the battery pack, the camcorder shuts off automatically to save power. To perform shooting again, push back and pull out the viewfinder again or close and re-open the LCD monitor.

Approximate Number of Storable Images

- The number increases or decreases depending on the Picture Quality/Image Size, etc.

Image Size/Picture Quality	SD Memory Card			
	8 MB**	16 MB*	32 MB*	64 MB*
640 x 480/FINE	47	95	205	425
640 x 480/STANDARD	160	295	625	1285
1024 x 768/FINE	21	47	95	200
1024 x 768/STANDARD	65	145	310	640
1280 x 960/FINE	13	29	60	125
1280 x 960/STANDARD	45	95	205	425
1600 x 1200/FINE	8	19	41	80
1600 x 1200/STANDARD	28	60	130	275

Image Size/Picture Quality	MultiMediaCard		
	8 MB*	16 MB*	32 MB*
640 x 480/FINE	55	105	215
640 x 480/STANDARD	190	320	645
1024 x 768/FINE	25	50	100
1024 x 768/STANDARD	75	160	320
1280 x 960/FINE	16	32	60
1280 x 960/STANDARD	50	105	215
1600 x 1200/FINE	10	21	42
1600 x 1200/STANDARD	34	65	135

- * Optional
- ** Provided

Interval Shooting

During Interval Shooting mode, the camcorder continues to take snapshots automatically with an interval of your desired setting.

- 1 Set "INT.SHOT" to "ON". (⇨ pg. 27, 30)
 - "INTERVAL" and "⌚" appears.
- 2 Set "INT.TIME" to the desired shooting interval. (⇨ pg. 27, 30)
- 3 Set the Power Switch to "A" or "M" while pressing down the Lock Button located on the switch.
- 4 Press **SNAPSHOT**.
 - First shot is taken after 2 seconds.
 - The "PHOTO" indicator appears while the snapshot is being taken.
 - The clock icon "⌚" turns while waiting for the next shot is being taken.
 - The next shot is being taken automatically when the shooting interval set in step 2 has passed.
- 5 Press **SNAPSHOT** to stop Interval Shooting.

To cancel Interval Shooting mode

Set "INT.SHOT" to "OFF" in step 1.

NOTES:

- To distinguish between still images taken in Interval Shooting mode and other still images, it is recommended that you reset the file names before shooting. (⇨ pg. 24)
- Interval Shooting will stop if the battery runs out of power or the Memory Card becomes full.
- The function "Animation" in the provided software "Digital Photo Navigator" can be used to create movie files from the captured still images (Windows® only). To create movie files with the Macintosh, it is recommended that you use the function "Creating a Slideshow From Still Images" in the commercial software "QuickTime Pro".

Normal Playback Of Images

Images shot with the camcorder are automatically numbered, then stored in numerical order in the memory card. You can view the stored images, one at a time, much like flipping through a photo album.

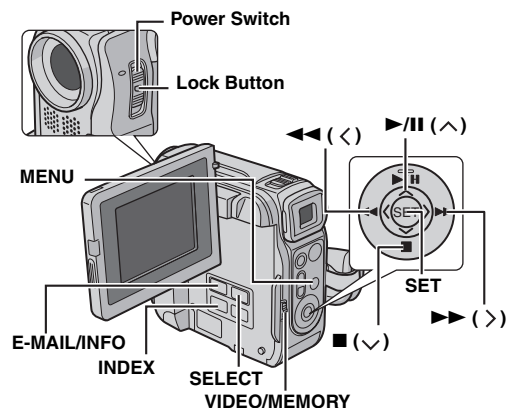

- 1 Load a memory card. (pg. 14)
- 2 Set the **VIDEO/MEMORY** Switch to "MEMORY".
- 3 Set the Power Switch to "PLAY" while pressing down the Lock Button located on the switch.
 - The type of file (IMAGE or E-MAIL CLIP) which has been played back at the last time is displayed.
- 4 If the video clip playback (E-MAIL CLIP, see the right column) screen appears, press **SELECT**. The MEMORY SELECT screen appears.
- 5 Press \wedge or \vee to select "IMAGE", and press **SET**. The image playback screen (IMAGE) appears.
- 6 Press \leftarrow to display the previous file. Press \rightarrow to display the next file.

NOTE:

Images shot and stored on the card with another device with resolutions other than "640 x 480", "1024 x 768", "1280 x 960" and "1600 x 1200" will be displayed as thumbnails only. These thumbnail images cannot be transferred to a PC.

Playback Zoom

Available only with the remote control (provided).
(pg. 20)

Auto Playback Of Images

You can run through all the images stored in memory card automatically.

- 1 Perform steps **1 – 5** in "Normal Playback Of Images".
- 2 Press \blacktriangleright /II to start Auto Playback.
 - If you press \blacktriangleleft during Auto Playback, files are displayed in descending order.
 - If you press \blacktriangleright during Auto Playback, files are displayed in ascending order.
- 3 To end Auto Playback, press \blacksquare .

To display the next image

To display the previous image

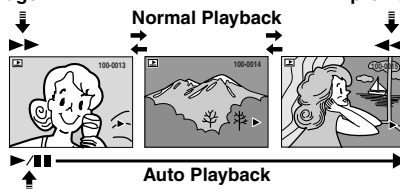

Playback Of Video Clips

You can view video clips (pg. 24) stored in the memory card.

- 1 Perform steps **1 – 3** in "Normal Playback Of Images".
- 2 If the image playback (IMAGE) screen appears, press **SELECT**. The MEMORY SELECT screen appears.
- 3 Press \wedge or \vee to select "E-MAIL CLIP", and press **SET**. The video clip playback screen (E-MAIL CLIP) appears.
- 4 Press \leftarrow to select the previous file. Press \rightarrow to select the next file.
- 5 To start playback, press \blacktriangleright /II.
- 6 To stop playback, press \blacksquare .



NOTES:

- The video clip files stored with this camcorder are compatible with MPEG4. Some MPEG4 files stored with other devices cannot be played back with this camcorder.
- 240 x 176 size video clip files made with other devices or video clip files that are longer than 3 minutes cannot be played back with this camcorder. "UNSUPPORTED FILE!" is displayed.
- You can also view video clips on your PC by using Windows® Media Player version 6.4 or later. Refer to the instructions of PC and software.

Index Playback Of Files

You can view several different files stored in the memory card at a time. This browsing capability makes it easy to locate a particular file you want.

1 For **Index Playback of image files**, perform steps **1 – 5** in “Normal Playback Of Images” (⇨ pg. 22).

For **Index Playback of video clip files**, perform steps

1 – 3 in “Playback Of Video Clips” (⇨ pg. 22).

2 Press **INDEX**. The Index Screen of the selected type of file appears.

3 Press </>/^/∨ to move the frame to the desired file.

4 Press **SET**. The selected file is displayed.

Selected file



Index number

Viewing File Information

You can get the relevant file information by pressing the **INFO** Button during normal playback or Index Playback.

FOLDER: Folder name

(⇨ pg. 24)

FILE: File name (⇨ pg. 24)

DATE: Date the file was made

SIZE: Image size

QUALITY: Picture quality

(IMAGE only)

TIME: Playback time (E-MAIL CLIP only)

PROTECT: When set to “ON”, the file is protected from accidental erasure. (⇨ pg. 25)

• Press the **INFO** Button again to close the Information Screen.

```
FOLDER : 100JVCGR
FILE   : DVC00010
DATE   : OCT 03 04
SIZE   : 1024X768
QUALITY : FINE
PROTECT : OFF
```

NOTE:

With images shot with other devices or processed on a PC, “QUALITY: -- --” will be displayed.

Removing On-Screen Display

1 Display the playback screen of normal images (⇨ pg. 22).

2 Press **MENU**. The Menu Screen appears.

3 Press ^ or ∨ to select “DISPLAY”, and press **SET**. The Sub Menu appears.

4 Press ^ or ∨ to select “OFF”, and press **SET**. The operation mode indicator, folder/file number and battery indicator () disappear.

• To display the indicators again, select “ON”.

Operation mode indicator

Folder/file number

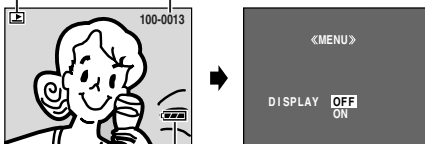

Battery indicator

E-Mail Clip Recording

You can make video clips in 160 x 120 pixels from real-time camera image or recorded video footage and store them in a memory card as files which can be conveniently sent via E-Mail.

To make video clips from real-time camera image

- 1 Load a memory card. (☞ pg. 14)
- 2 Set the **VIDEO/MEMORY** Switch to "MEMORY".
- 3 Set the Power Switch to "A" or "M" while pressing down the Lock Button located on the switch.
- 4 Press **E-MAIL** to engage the E-Mail Clip Record-Standby mode.
 - "E-CLIP" appears.
- 5 Press the Recording Start/Stop Button to start recording.
- 6 Press the Recording Start/Stop Button to stop recording.
 - "COMPLETED" is displayed, then the camcorder re-enters the E-Mail Clip Record-Standby mode.
- 7 Press **E-MAIL** to end E-Mail Clip Recording.

Remaining time



Approximate recording time

MultiMediaCard		SD Memory Card	
8 MB*	8 min.	8 MB**	7 min.
16 MB*	17 min.	16 MB*	15 min.
32 MB*	34 min.	32 MB*	33 min.

* Optional

** Provided

To make video clips from recorded video footage

- 1 Load a cassette. (☞ pg. 14)
- 2 Load a memory card. (☞ pg. 14)
- 3 Set the **VIDEO/MEMORY** Switch to "VIDEO".
- 4 Set the Power Switch to "PLAY" while pressing down the Lock Button located on the switch.
- 5 Press ►/II to start video playback.
- 6 Press **E-MAIL** to engage the E-Mail Clip Record-Standby mode.
 - "E-CLIP" appears.
 - To cancel E-Mail Clip Recording, press **E-MAIL** again or press ■ to stop video playback.
- 7 At the point you want to start dubbing, press the Recording Start/Stop Button to start E-Mail Clip Recording.
- 8 Press the Recording Start/Stop Button to stop E-Mail Clip Recording.
 - "COMPLETED" is displayed, then the camcorder re-enters the E-Mail Clip Record-Standby mode.
- 9 Press **E-MAIL** to end E-Mail Clip Recording.

NOTES:

- Approximate maximum recording time per video clip is 3 minutes.
- The video clip files stored with this camcorder are compatible with MPEG4. Some MPEG4 files stored with other devices cannot be played back with this camcorder.

Dubbing Still Images Recorded On A Tape To A Memory Card

Still images can be dubbed from a tape to a memory card.

- 1 Load a cassette. (☞ pg. 14)
- 2 Load a memory card. (☞ pg. 14)
- 3 Set the **VIDEO/MEMORY** Switch to "VIDEO".
- 4 Set the Power Switch to "PLAY" while pressing down the Lock Button located on the switch.
- 5 Set "COPY" to "ON". (☞ pg. 27, 30)
- 6 Press ►/II to start playback.
- 7 At the point you want to dub, press ►/II again to engage Still Playback.
- 8 To dub the image, press **SNAPSHOT**.
 - The "▶ [P]" indication appears during dubbing.

NOTES:

- To use Playback Special effects with a video image you wish to dub, perform up to step 8 using the remote control (provided). (☞ pg. 20)
- Images are dubbed in 640 x 480 pixels.
- The "SNAP MODE" selection can be applied to the image. (☞ pg. 28)

Resetting The File Name

By resetting the file name, a new folder will be made. The new files you are going to make will be stored in the new folder. It is convenient to separate the new files from previously made files. (Available only for Image and video clip files.)

- 1 **To reset the file name...**
 - ...for images, display its playback screen. (☞ pg. 22)
 - ...for video clips, display its playback screen. (☞ pg. 22)
- 2 Press **MENU**. The Menu Screen appears.
- 3 Press ^ or v to select "NO. RESET", and press **SET**. The NO. RESET screen appears.
- 4 Press ^ or v to select "EXECUTE", and press **SET**. The new folder (such as "101JVCGR") will be made and the file name of the next shot starts from DVC00001.

NOTE:

If the file name reaches DVC09999, a new folder (such as "101JVCGR") will be made and the file name will start again from DVC00001.

Protecting Files

The Protect mode helps prevent the accidental erasure of files.

1 To protect the file...

...for images, display its playback screen. (⇨ pg. 22)
 ...for video clips, display its playback screen. (⇨ pg. 22)

2 Press **MENU**. The Menu Screen appears.

3 Press \wedge or \vee to select "PROTECT", and press **SET**. The Sub Menu appears.

To protect the currently displayed file

4 Press \wedge or \vee to select "CURRENT", and press **SET**. The PROTECT screen appears.

5 Press \leftarrow or \rightarrow to select the desired file.



6 Press \wedge or \vee to select "EXECUTE", and press **SET**.

- To cancel protection, select "RETURN".
- Repeat steps **5** and **6** for all files you want to protect.

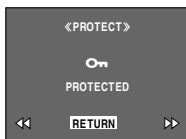

To protect all files stored in the memory card

4 Press \wedge or \vee to select "PROT.ALL", and press **SET**. The PROTECT screen appears.

5 Press \wedge or \vee to select "EXECUTE", and press **SET**.
 • To cancel protection, select "RETURN".

NOTES:

- If the "Ⓢ" mark appears, the currently displayed file is protected.
- When the memory card is initialized or corrupted, even protected files are deleted. If you do not want to lose important files, transfer them to a PC and save them.

To Remove Protection

Before doing the following, perform steps **1** – **3** in "Protecting Files".

To remove protection from the currently displayed file

4 Press \wedge or \vee to select "CURRENT", and press **SET**. The PROTECT screen appears.

5 Press \leftarrow or \rightarrow to select the desired file.

6 Press \wedge or \vee to select "EXECUTE", and press **SET**.

- To cancel selection, select "RETURN".
- Repeat steps **5** and **6** for all files you want to remove protection.

To remove protection from all files stored in the memory card

4 Press \wedge or \vee to select "CANC.ALL", and press **SET**. The PROTECT screen appears.

5 Press \wedge or \vee to select "EXECUTE", and press **SET**.
 • To cancel selection, select "RETURN".

Deleting Files

Previously stored files can be deleted either one at a time or all at once.

1 To delete the file...

...for images, display its playback screen. (⇨ pg. 22)
 ...for video clips, display its playback screen. (⇨ pg. 22)

2 Press **MENU**. The Menu Screen appears.

3 Press \wedge or \vee to select "DELETE", and press **SET**. The Sub Menu appears.

To delete the currently displayed file

4 Press \wedge or \vee to select "CURRENT", and press **SET**. The DELETE screen appears.

5 Press \leftarrow or \rightarrow to select the desired file.

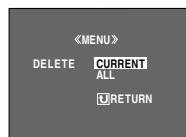

6 Press \wedge or \vee to select "EXECUTE", and press **SET**.

- To cancel deletion, select "RETURN".
- Repeat steps **5** and **6** for all files you want to delete.

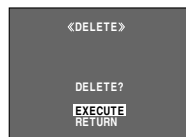

NOTE:

If the "Ⓢ" mark appears, the selected file is protected and cannot be deleted.

To delete all files stored in the memory card

4 Press \wedge or \vee to select "ALL", and press **SET**. The DELETE screen appears.

5 Press \wedge or \vee to select "EXECUTE", and press **SET**.
 • To cancel deletion, select "RETURN".

NOTES:

- Protected files (see the left column) cannot be deleted. To delete them, remove protection first.
- Once files are deleted, they cannot be restored. Check files before deleting.

CAUTION:

Do not remove the memory card or perform any other operation (such as turning off the camcorder) during deletion. Also, be sure to use the provided AC Adapter, as the memory card may be corrupted if the battery becomes exhausted during deletion. If the memory card becomes corrupted, initialize it. (⇨ pg. 26)

Setting Print Information (DPOF Setting)

This camcorder is compatible with the DPOF (Digital Print Order Format) standard in order to support future systems such as automatic printing. You can select one of the 2 print information settings for images stored in the memory card: "To Print All Still Images (One Print For Each)" or "To Print By Selecting Still Images And Number Of Prints".

NOTES:

- If you load a memory card already set as shown below in a printer compatible with DPOF, it will make prints of the selected still images automatically.
- To print images recorded on a tape, first dub them to a memory card. (☞ pg. 24)

To Print All Still Images (One Print For Each)

1 Display the playback screen of normal images (☞ pg. 22).

2 Press **MENU**. The Menu Screen appears.

3 Press \wedge or \vee to select "DPOF", and press **SET**. The Sub Menu appears.

4 Press \wedge or \vee to select "ALL 1", and press **SET**. The DPOF screen appears.

5 Press \wedge or \vee to select "EXECUTE", and press **SET**. The normal playback screen appears.

- To cancel selection, select "RETURN".



To Print By Selecting Still Images And Number Of Prints

1 Perform steps **1 – 3** in "To Print All Still Images (One Print For Each)".

2 Press \wedge or \vee to select "CURRENT", and press **SET**. The DPOF screen appears.

3 Press \leftarrow or \rightarrow to select the desired file.

4 Press \wedge or \vee to select the number indication (00), and press **SET**.

5 Select the number of prints by pressing \wedge to increase the number, or \vee to decrease the number, and press **SET**.

- Repeat steps **3** through **5** for the desired number of prints.
- The number of prints can be set up to 15.
- To correct the number of prints, select the image again and change the number.

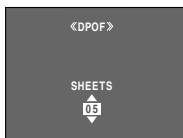

6 Press \wedge or \vee to select "RETURN", and press **SET**. The "SAVE?" appears.

- If you did not change any settings in step **3** through **5**, the Menu Screen reappears.

7 Press \wedge or \vee to select "EXECUTE" to save the setting you have just made, and press **SET**.

- To cancel selection, select "CANCEL".



To Reset The Number Of Prints

1 Perform steps **1 – 3** in "To Print All Still Images (One Print For Each)".

2 Press \wedge or \vee to select "RESET", and press **SET**. The DPOF screen appears.

3 Press \wedge or \vee to select "EXECUTE", and press **SET**. The normal playback screen appears.

- To cancel selection, select "RETURN".
- The number of prints is reset to 0 for all still images.

CAUTION:

While performing the above, never disconnect power, as this may cause the memory card to be corrupted.

Initializing A Memory Card

You can initialize a memory card any time.

After initializing, all files and data stored in the memory card, including those which have been protected, are cleared.

1 Set the **VIDEO/MEMORY** Switch to "MEMORY".

2 Set the Power Switch to "PLAY" while pressing down the Lock Button located on the switch.

3 Press **MENU**. The Menu Screen appears.

4 Press \wedge or \vee to select "FORMAT", and press **SET**. The FORMAT screen appears.

5 Press \wedge or \vee to select "EXECUTE", and press **SET**. The memory card is initialized.

- When initialization is finished, "NO IMAGES STORED" or "NO E-MAIL CLIP STORED" appears.

- To cancel initialization, select "RETURN".



CAUTION:

Do not perform any other operation (such as turning off the camcorder) during initialization. Also, be sure to use the provided AC Adapter, as the memory card may be corrupted if the battery becomes exhausted during initialization. If the memory card becomes corrupted, initialize it.

Changing The Menu Settings

This camcorder is equipped with an easy-to-use, on-screen menu system that simplifies many of the more detailed camcorder settings. (pg. 28 – 31)

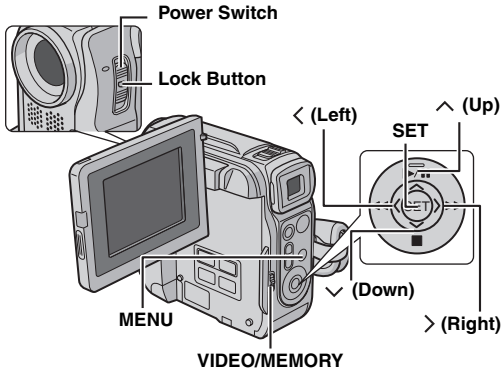

1 For Video and D.S.C. Recording Menus:

- Set the VIDEO/MEMORY Switch to "VIDEO" or "MEMORY".
- Set the Power Switch to "M" while pressing down the Lock Button located on the switch.

For Video Playback Menus:

- Set the VIDEO/MEMORY Switch to "VIDEO".
- Set the Power Switch to "PLAY" while pressing down the Lock Button located on the switch.
- For D.S.C. Playback Menus, refer to "D.S.C. PLAYBACK" (pg. 22).

2 Open the LCD monitor fully. (pg. 15)

3 Press MENU. The Menu Screen appears.

4 Press ^ or v to select the desired function, and press SET. The selected function menu appears.

Screen for Video and D.S.C. Recording Menu

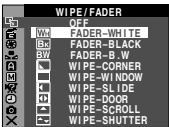

Screen for Video Playback Menu

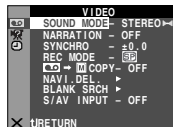

5 Setting procedure hereafter depends on the selected function.

Menus without Sub Menus

- WIPE/FADER (pg. 34)
- PROGRAM AE (pg. 35)
- EXPOSURE (pg. 33)
- W. BALANCE (pg. 34)

1) Press ^ or v to select the desired parameter.

• Example: PROGRAM AE Menu

2) Press SET. Selection is complete. The Menu Screen returns.

• Repeat the procedure if you wish to set other function menus.

3) Press SET. The Menu Screen closes.

Selected menu icon blinks.

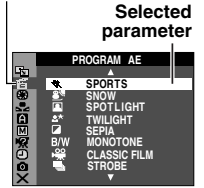

Selected parameter

Menus with Sub Menus

- CAMERA (pg. 28)
- MANUAL (pg. 28)
- SYSTEM (pg. 29)
- CAMERA DISPLAY (pg. 29)
- DSC (pg. 30)
- VIDEO (pg. 30)
- VIDEO DISPLAY (pg. 31)

1) Press ^ or v to select the desired function, and press SET. The Sub Menu appears.

• Example: CAMERA Menu

2) Press ^ or v to select the desired parameter.

3) Press SET. Selection is complete.

• Repeat the procedure if you wish to set other function menus.

4) Press SET. The Menu Screen returns.

• Repeat the procedure if you wish to set other function menus.

5) Press SET. The Menu Screen closes.

Selected menu icon blinks.

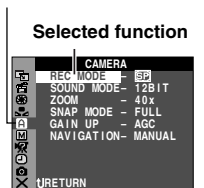

Selected function

Sub Menu

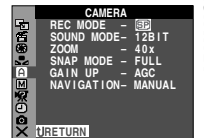

Recording Menus

CAMERA

The **“CAMERA”** settings are effective when the Power Switch is set to both **“A”** and **“M”**. However, the menu settings can be changed only when the Power Switch is set to **“M”**.

[] = Factory-preset

REC MODE

[SP]: To record in the SP (Standard Play) mode
LP: Long Play—more economical, providing 1.5 times the recording time.

NOTES:

- Audio Dubbing (⇨ pg. 40) and Insert Editing (⇨ pg. 40) are possible on tapes recorded in the SP mode.
- If the recording mode is switched, the playback picture will be blurred at the switching point.
- It is recommended that tapes recorded in the LP mode on this camcorder be played back on this camcorder.
- During playback of a tape recorded on another camcorder, blocks of noise may appear or there may be momentary pauses in the sound.

SOUND MODE

[12 BIT]: Enables video recording of stereo sound on four separate channels, and is recommended for use when performing Audio Dubbing. (Equivalent to the 32 kHz mode of previous models)

16 BIT: Enables video recording of stereo sound on two separate channels. (Equivalent to the 48 kHz mode of previous models)

ZOOM

10X: When set to “10X” while using digital zoom, the zoom magnification will reset to 10X since digital zoom will be disengaged.

[40X]*: Allows you to use the Digital Zoom. By digitally processing and magnifying images, zooming is possible from 10X (the optical zoom limit), to a maximum of 40X digital magnification.

500X*: Allows you to use the Digital Zoom. By digitally processing and magnifying images, zooming is possible from 10X (the optical zoom limit), to a maximum of 500X digital magnification.

* Available only when the **VIDEO/MEMORY** Switch is set to “VIDEO”.

SNAP MODE

[FULL]: Snapshot mode with no frame

NEGA: Nega mode

PIN-UP: Pin-Up mode

FRAME: Snapshot mode with frame



[FULL]



NEGA



PIN-UP





FRAME

For details on the procedure, refer to “Snapshot (For Video Recording)” (⇨ pg. 32).

GAIN UP

OFF: Allows you to shoot dark scenes with no picture brightness adjustment.

[AGC]: The overall appearance may be grainy, but the image is bright.

AUTO : The shutter speed is automatically adjusted. Shooting a subject in low or poor lighting at slow shutter speed provides a brighter image than in the AGC mode, but the subject's movements are not smooth or natural. The overall appearance may be grainy. While the shutter speed is being automatically adjusted, “A” is displayed.

NAVIGATION

[MANUAL]: Enables thumbnail images to be made manually. (⇨ pg. 36)

5SEC / 15SEC / 30SEC / 60SEC:

The captured image is stored in the memory card as a thumbnail image when the recording time is over the navigation time.

For example, “5SEC” is suitable to record short scenes with the thumbnail images. (⇨ pg. 35) However, the stored thumbnail images may take up a lot of memory. In this case, using the memory card with large capacity is recommended.

OFF: Disables the function.

- The “M” indicator appears when “NAVIGATION” is set to other than “MANUAL” and “OFF”.

MANUAL

The **“MANUAL”** settings are effective only when the Power Switch is set to **“M”**.

[] = Factory-preset

DIS

OFF: Disables the function.

[ON] : To compensate for unstable images caused by camera-shake, particularly at high magnification.

NOTES:

- Accurate stabilization may not be possible if hand shake is excessive, or depending on the shooting condition.
- The “M” may change color from white to blue and start blinking or go out completely if the Stabilizer cannot be used.
- Switch off this mode when recording with the camcorder on a tripod.

SELF-TIMER

[OFF] / ON 

⇨ pg. 31, “Self-Timer”

5S

[OFF]: Disables 5-Second Recording.

5S: Enables 5-Second Recording. (⇨ pg. 32)

Anim.: Allows you to record a few frames only. By using an inanimate object and changing its position between shots, you can record the subject as though it is moving.

TELE MACRO

[OFF]: Disables the function.

ON: When the distance to the subject is less than 1 m (3.3 ft), set “TELE MACRO” to “ON”. You can shoot a subject as large as possible at a distance of approx. 60 cm (2 ft).

NOTE:

Depending on the zoom position, the lens may go out of focus.

WIDE MODE

[OFF]: Records with no change in the screen ratio. For playback on a TV with a normal screen ratio.
CINEMA* : Inserts black bands at the top and bottom of the screen. The indicator appears. During playback on wide-screen TVs, the black bands at the top and bottom of the screen are cut and the screen ratio becomes 16:9. When using this mode, refer to your wide-screen TV's instruction manual. During playback/recording on 4:3 TVs/LCD monitor/viewfinder, black bands are inserted at the top and bottom of the screen and the image appears like a letter boxed 16:9 movie.
SQUEEZE* : For playback on TVs with an aspect ratio of 16:9. Naturally expands the image to fit the screen without distortion. The indicator appears. When using this mode, refer to your wide-screen TV's instruction manual. During playback/recording on 4:3 TVs/LCD monitor/viewfinder, the image is elongated vertically.
D.WIDE* : The indicator appears. The zoom range is extended beyond the maximum optical zoom wide angle range. This mode's wide angle setting is equivalent to using a 0.7X wide conversion lens. Zooming is possible from 0.7X to 10X. This mode is suitable for shooting in a small room.

* Available only when the VIDEO/MEMORY Switch is set to "VIDEO".

WIND CUT

[OFF]: Disengages the function.
ON : Helps cut down on noise created by wind. The indicator appears. The quality of the sound will change. This is normal.

SYSTEM

The SYSTEM" functions which are set when the Power Switch is set to are also applied when the Power Switch is set to "PLAY".

[] = Factory-preset

BEEP

OFF: Even though not heard while shooting, shutter sound is recorded on the tape.
BEEP: The beep sounds when the power is turned on or off, and at the beginning and end of recording. It also activates the shutter sound effect. (☞ pg. 21, 32)
[MELODY]: Instead of a beep, a melody sounds when any operation is performed. It also activates the shutter sound effect. (☞ pg. 21, 32)

TALLY

OFF: The tally lamp remains off at all times.
[ON]: The tally lamp comes on to signal the start of recording.

REMOTE

OFF: Disables the remote control operations.
[ON]: Enables the remote control operations.

DEMO MODE

OFF: Automatic demonstration will not take place.
[ON]: Demonstrates certain functions such as Program AE with special effects, etc., and can be used to confirm how these functions operate. Demonstration starts in the following cases:

- When the Menu Screen is closed after "DEMO MODE" is turned "ON".
- With "DEMO MODE" set to "ON", if there is no operation for about 3 minutes after the Power Switch is set to or .
- Performing any operation during the demonstration stops the demonstration temporarily. If no operation is performed for more than 3 minutes after that, the demonstration will resume.

NOTES:

- If a cassette is in the camcorder, the demonstration cannot be turned on.
- "DEMO MODE" remains "ON" even if the camcorder power is turned off.
- If "DEMO MODE" remains "ON", some functions will not be available. After viewing demo, set to "OFF".

PRIORITY

[LCD]: The image is displayed on the LCD monitor when the viewfinder is pulled out while the LCD monitor is opened.
FINDER: The image is displayed in the viewfinder when the viewfinder is pulled out while the LCD monitor is opened.

CAM RESET

EXECUTE: Resets all settings to the factory-preset.
[RETURN]: Does not reset all settings to the factory-preset.

CAMERA DISPLAY

- The (CAMERA DISPLAY) settings are effective even when the Power Switch is set to . However, the menu settings can be changed only when the Power Switch is set to .
 - The (CAMERA DISPLAY) settings except "BRIGHT" and "AUX MIC" are effective only for shooting.
- [] = Factory-preset

BRIGHT

☞ pg. 13, "Brightness Adjustment Of The Display"

ON SCREEN

LCD: Keeps the camcorder's display (except the date, time and time code) from appearing on the connected TV screen.
[LCD/TV]: Makes the camcorder's display appear on screen when the camcorder is connected to a TV.

DATE/TIME

OFF: The date/time does not appear.
[AUTO]: Displays the date/time for approx. 5 seconds when the Power Switch is set from "OFF" to or .
ON: The date/time is always displayed.
 • The date indication can also be turned on/off by pressing the **DISPLAY** Button on the remote control (provided).
 (☞ pg. 18, 37, 42)

TIME CODE

[OFF]: Time code is not displayed.

ON: Time code is displayed on the camcorder and on the connected TV. Frame numbers are not displayed during recording. (☞ pg. 17)

AUX MIC

OFF: Auxiliary microphone level indicator does not appear.

[ON]: Displays auxiliary microphone level indicator when optional microphone is connected. (☞ pg. 7)

CLOCK ADJ.

☞ pg. 12, "Date/Time Settings"



[] = Factory-preset

QUALITY**[FINE] / STANDARD**

The Picture Quality mode can be selected to best match your needs. Two Picture Quality modes are available: FINE () and STANDARD () (in order of quality).

NOTE:

The number of storable images depends on the selected picture quality as well as the composition of the subjects in the images and the type of memory card being used. (☞ pg. 21)

IMAGE SIZE

640 x 480 / 1024 x 768 / [1280 x 960] / 1600 x 1200

The Image Size mode can be selected to best match your needs. (☞ pg. 21)

NOTE:

The setting can be changed only when the **VIDEO/MEMORY** Switch is set to "MEMORY".

REC SELECT

[(TAPE)]: When Snapshot recording is performed with the **VIDEO/MEMORY** Switch set to "VIDEO", still images are recorded only onto the tape.

➔ / ➔ (TAPE/CARD): When Snapshot recording is performed with the **VIDEO/MEMORY** Switch set to "VIDEO", still images are recorded not only onto the tape but also in the memory card (640 x 480 pixels). In this mode, the "SNAP MODE" selection in CAMERA Menu is also applicable to memory card recording.

INT.SHOT

[OFF]: Disables the function.

ON: Enables interval shooting. (☞ pg. 21)

INT.TIME

15SEC / 30SEC / [1MIN] / 2MIN / 5MIN / 10MIN / 30MIN / 60MIN

Allows you to select the shooting interval for interval shooting. (☞ pg. 21)

Playback Menus **VIDEO**

[] = Factory-preset

SOUND MODE and NARRATION

During tape playback, the camcorder detects the sound mode in which the recording was made, and plays the sound back. Select the type of sound to accompany your playback picture. According to the menu access explanation on page 27, select "SOUND MODE" or "NARRATION" from the Menu Screen and set it to the desired parameter.

SOUND MODE

[STEREO]: Sound is output on both "L" and "R" channels in stereo.

SOUND L]: Sound from the "L" channel is output.

SOUND R]: Sound from the "R" channel is output.

NARRATION

[OFF]: Original sound is output on both "L" and "R" channels in stereo.

ON: Dubbed sound is output on both "L" and "R" channels in stereo. (☞ pg. 40)

MIX: Original and dubbed sounds are combined and output in stereo on both "L" and "R" channels.

SYNCHRO

☞ pg. 44, "For More Accurate Editing"

REC MODE [SP] / LP

Allows you to set the video recording mode (SP or LP) depending on your preference. It is recommended you use "REC MODE" in VIDEO Menu when using this camcorder as a recorder during dubbing. (☞ pg. 37, 38)

 COPY

[OFF]: When the **SNAPSHOT** button is pressed during tape playback, the playback image pauses and normal playback will resume after approximately 6 seconds. (The still image is not recorded.)

ON: Enables dubbing of images recorded on a tape to a memory card. (☞ pg. 24)

NAVI.DEL.**IMAGE SEL. / TAPE SEL. / ALL / RETURN**

☞ pg. 36, "To delete thumbnail images"

BLANK SRCH

☞ pg. 18, "Blank Search"

S/AV INPUT

[OFF]: Disables audio/video signal input from the AV connector. (☞ pg. 37)

AV.IN: Enables audio/video signal input from the AV connector. (☞ pg. 37)

S.IN: Enables audio/S-video signal input from the AV connector. (☞ pg. 37)

SYSTEM

Each setting is linked with "SYSTEM", which appears when the Power Switch is set to "M".

- The parameters are the same as in the description on page 29.

VIDEO DISPLAY

The "VIDEO" (VIDEO DISPLAY) settings are effective only for video playback except "BRIGHT" and "AUX MIC".

- The parameters (except "OFF" in ON SCREEN settings) are the same as in the description (CAMERA DISPLAY) on page 29.

[] = Factory-preset

BRIGHT

pg. 13, "Brightness Adjustment Of The Display"

ON SCREEN OFF / [LCD] / LCD/TV

When set to "OFF", the camcorder's display disappears.

DATE/TIME [OFF] / AUTO / ON

When set to "AUTO", the date/time are displayed in the following cases:

- When playback starts. The camcorder displays the date/time when scenes are recorded.
- When the date is changed during playback.

TIME CODE [OFF] / ON

AUX MIC OFF / [ON]

pg. 30, "AUX MIC"

LED Light

LED Light can be used to brighten the subject in the dark place during video recording or D.S.C. shooting.

1 Press **LIGHT** repeatedly to change the setting.

OFF: Turns off the light.

ON: The light is on always. (☞ appears.)

AUTO: The light turns on automatically when dark. (☞A appears.)

2 Press the Recording Start/Stop Button to start video recording or **SNAPSHOT** to shoot a still image.

NOTES:

- Be careful not to point the LED Light directly to eyes.
- If the light does not reach the subject, the Night-Alive function will be activated, and makes it possible to shoot the subject brighter.
- There is a difference in the brightness of the images shot between the center area which is illuminated by the LED Light and the surrounding areas (which will be darker).
- Since subjects are shot at a reduced shutter speed when the LED Light setting is "ON", they will appear slightly blurred.
- Under certain low light conditions the DIS function will not be available. The "DIS" indicator blinks. (pg. 28)

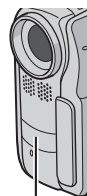

LED Light

Self-Timer

Once the camcorder is set, the camcorder operator can become part of the scene in a more natural way, adding the final touch to a memorable picture.

1 Set the Power Switch to "M".

2 Set "SELF-TIMER" to "ON" (☺). (pg. 27, 28)

- The "☺" indicator appears.

3 For video recording, press the Recording Start/Stop Button.

- The tally lamp starts blinking.
- After 15 seconds, the beep sounds and video recording starts. The tally lamp stays on.

To stop Self-Timer recording, press the Recording Start/Stop Button again.

- The camcorder re-enters Record-Standby mode.

OR

3 For snapshot, press **SNAPSHOT**.

- The tally lamp starts blinking.
- After 15 seconds, the beep sounds and snapshot recording starts. The tally lamp turns off. After that, the camcorder re-enters Record-Standby mode.

4 To end Self-Timer recording, select "OFF" in step 2.

NOTE:

If "BEEP" and "TALLY" are set to "OFF" (pg. 29), the beep does not sound and the tally lamp does not light.

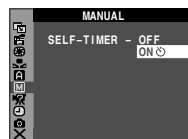

5-Second Recording

Record a vacation or an important event in 5-second clips to keep the action moving. This function is available only for video recording.

- 1 Set "5S" to "5S". (☞ pg. 28)
- The "5S" indicator appears.

2 Press the Recording Start/Stop Button to start recording, and after 5 seconds the camcorder enters Record-Standby mode automatically.

- Even if you press the Recording Start/Stop Button again within 5 seconds after recording starts, Record-Standby mode is not engaged.

3 To exit the 5S mode, select "OFF" in step 1.

To take a snapshot in the 5-second recording mode

Instead of pressing the Recording Start/Stop Button in step 2, select the desired Snapshot mode in CAMERA Menu (☞ pg. 28), then press **SNAPSHOT**. The camcorder records a 5-second still. When "5S" is set to "Anim.", this function is not available.

NOTE:

When "5S" is set to "Anim.", the 5-Second Recording mode is not available. Animation recording of a few frames only is taken instead.

Night-Alive

Makes dark subjects or areas even brighter than they would be under good natural lighting. Although the recorded image is not grainy, it may look as if it is strobing due to the slow shutter speed.

- 1 Set the Power Switch to "M".

2 Press **NIGHT** so that the Night-Alive indicator "0.0" appears.

- The shutter speed is automatically adjusted to provide up to 30 times sensitivity.
- "A" appears beside "0.0" while the shutter speed is being automatically adjusted.

To deactivate Night-Alive

Press **NIGHT** again so that the Night-Alive indicator disappears.

NOTES:

- During Night-Alive, the following functions or settings cannot be activated and its indicator blinks or goes out:
 - Some modes of "Program AE With Special Effects" (☞ pg. 35).
 - "GAIN UP" in CAMERA Menu. (☞ pg. 28)
 - "DIS" in MANUAL Menu. (☞ pg. 28)
- During Night-Alive, it may be difficult to bring the camcorder into focus. To prevent this, use of a tripod is recommended.

Snapshot (For Video Recording)

This feature lets you record still images that look like photographs onto a tape.

- 1 Set the **VIDEO/MEMORY** Switch to "VIDEO".

2 Set the Power Switch to "M".

3 Set "SNAP MODE" to the desired mode. (☞ pg. 27, 28)

4 Press **SNAPSHOT**.

- There is the sound effect of a shutter closing.
- The "PHOTO" indication appears and a still image will be recorded for approx. 6 seconds, then the camcorder re-enters the Record-Standby mode.
- You can perform Snapshot also during recording. A still image will be recorded for approx. 6 seconds, then the normal recording resumes.
- Regardless of the Power Switch position ("A" or "M"), Snapshot recording takes place using the selected Snapshot mode.

Motor Drive Mode

Keeping **SNAPSHOT** pressed in step 4 provides an effect similar to serial photography. (Interval between still images: approx. 1 second)

- The Motor Drive mode is disabled when "REC SELECT" is set to "▶▶▶/▶▶▶". (☞ pg. 30)

Manual Focus

The camcorder's Full Range AF system offers continuous shooting ability from close-up (as close as approx. 5 cm (2") to the subject) to infinity. However, correct focus may not be obtained depending on the shooting condition. In this case, use the manual focus mode.

- 1 Set the Power Switch to "M".

2 Press **FOCUS**. The manual focus indicator appears.

3 Press < or > to focus on a subject.

- When the focus level cannot be adjusted any further or closer, "▲" or "●" will blink.

4 Press **SET**. Focus adjustment is complete.

To reset to Auto Focus

Press **FOCUS** twice or set the Power Switch to "A".

Manual focus is recommended in situations listed below.

- When two subjects overlap in the same scene.
 - When illumination is low.*
 - When the subject has no contrast (difference in brightness and darkness), such as a flat, one-color wall, or a clear, blue sky.*
 - When a dark object is barely visible in the LCD monitor or the viewfinder.*
 - When the scene contains minute patterns or identical patterns that are regularly repeated.
 - When the scene is affected by sunbeams or light reflecting off the surface of a body of water.
 - When shooting a scene with a high-contrast background.
- * The following low-contrast warnings appear blinking: ▲, ◀, ▶ and ●.



Manual focus indicator

Exposure Control

Manual exposure control is recommended in the following situations:

- When shooting using reverse lighting or when the background is too bright.
- When shooting on a reflective natural background such as the beach or when skiing.
- When the background is overly dark or the subject is bright.

1 Set the Power Switch to "M".

2 Set "E" to "MANUAL". (⇨ pg. 27)

- The exposure control indicator appears.

3 To brighten the image, press >. To darken the image, press <. (maximum ±6)

- +3 exposure has the same effect as the backlight compensation. (⇨ pg. 33)

- -3 exposure has the same effect as when "E" is set to "SPOTLIGHT". (⇨ pg. 35)

4 Press SET. Exposure adjustment is complete.

To return to automatic exposure control

Select "AUTO" in step 2. Or, set the Power Switch to "A".

NOTES:

- You cannot use the manual exposure control at the same time when "E" is set to "SPOTLIGHT" or "SNOW" (⇨ pg. 35), or with the backlight compensation.
- If the adjustment does not cause any visible change in brightness, set "GAIN UP" to "AUTO". (⇨ pg. 27, 28)

Iris Lock

Like the pupil of the human eye, the iris contracts in well-lit environments to keep too much light from entering, and dilates in dim environments to allow in more light. Use this function in the following situations:

- When shooting a moving subject.
- When the distance to the subject changes (so its size in the LCD monitor or the viewfinder changes), such as when the subject is backing away.
- When shooting on a reflective natural background such as the beach or when skiing.
- When shooting objects under a spotlight.
- When zooming.

1 Set the Power Switch to "M".

2 Set "E" to "MANUAL". (⇨ pg. 27)

- The exposure control indicator appears.

3 Adjust zoom so that the subject fills the LCD monitor or the viewfinder, then press and hold SET for over 2 seconds. The exposure control indicator and the "E" indication appear.

4 Press SET. The "E" indication changes to "I" and the iris is locked.

To return to automatic iris control

Select "AUTO" in step 2. Or, set the Power Switch to "A".

- The exposure control indicator and "I" disappear.

To lock the exposure control and the iris

After step 2, adjust the exposure by pressing < or >. Then lock the iris in steps 3 and 4. For automatic locking, select "AUTO" in step 2. The exposure control and the iris become automatic.

Backlight Compensation

Backlight compensation brightens the subject quickly. With simple operation, backlight compensation feature brightens the dark subject portion by increasing the exposure.

1 Set the Power Switch to "M".

2 Press BACK LIGHT so that the Backlight Compensation indicator "B" appears.

To cancel Backlight Compensation

Press BACK LIGHT twice so that the "B" indicator disappears.

NOTE:

Using Backlight Compensation may cause the light around the subject to become too bright and the subject to become white.

Spot Exposure Control

Selection of a spot metering area enables more precise exposure compensation. You can select one of the three metering areas on the LCD monitor/viewfinder.

1 Set the Power Switch to "M".

2 Press BACK LIGHT twice so that the Spot Exposure Control indicator "S" appears.

- A spot metering area frame "C" appears at the center of the LCD monitor/viewfinder.

3 Press < or > to select the desired spot metering area frame.

4 Press SET.

- Spot Exposure Control is engaged.
- Exposure is adjusted to make the brightness of the selected area most appropriate.

To lock the iris

After step 3, press and hold SET over 2 seconds. The "I" indication appears and the iris is locked.

To cancel Spot Exposure Control

Press BACK LIGHT once so that the "S" indicator disappears.

NOTES:

- You cannot use the Spot Exposure Control at the same time with following functions.
 - "SQUEEZE" in "WIDE MODE" (⇨ pg. 29)
 - "SPOTLIGHT", "STROBE" or "SNOW" in "PROGRAM AE" (⇨ pg. 35)
 - Digital Zoom (⇨ pg. 16)
 - Manual Exposure Control
- Depending on the shooting location and condition, optimum result may not be attained.

White Balance Adjustment

The white balance that refers to the correctness of color reproduction under various lighting. If the white balance is correct, all other colors will be accurately reproduced. The white balance is usually adjusted automatically. However, more advanced camcorder operators control this function manually to achieve a more professional color/tint reproduction.

To change the setting

Set "☒" to the desired mode. (☞ pg. 27)

- The selected mode indicator except "AUTO" appears.

[AUTO]: White balance is adjusted automatically.

☒ **MWB**: Adjust the white balance manually when shooting under various types of lighting. (☞ "Manual White Balance Adjustment")

☀ **FINE**: Outdoors on a sunny day.

☁ **CLOUD**: Outdoors on a cloudy day.

☀ **HALOGEN**: A video light or similar type of lighting is used.

[] = Factory-preset

To return to automatic white balance

Set "☒" to "AUTO". (☞ pg. 27)

Or, set the Power Switch to "A".

Manual White Balance Adjustment

Adjust the white balance manually when shooting under various types of lighting.

1 Set the Power Switch to "M".

2 Select "MWB" in "W.BALANCE" menu. (☞ pg. 27)

- The ☒ indication blinks slowly.

3 Hold a sheet of plain white paper in front of the subject. Adjust zoom or position yourself so that the white paper fills the screen.

4 Press and hold SET until ☒ begins blinking rapidly.

- When the setting is completed, ☒ resumes normal blinking.

5 Press SET twice. The Menu Screen closes and the Manual White Balance indicator ☒ is displayed.

NOTES:

- In step **3**, it may be difficult to focus on the white paper. In such a case, adjust focus manually. (☞ pg. 32)
- A subject can be shot under various types of lighting conditions indoors (natural, fluorescent, candlelight, etc.). Because the color temperature is different depending on the light source, the subject tint will differ depending on the white balance settings. Use this function for a more natural result.
- Once you adjust white balance manually, the setting is retained even if the power is turned off or the battery removed.

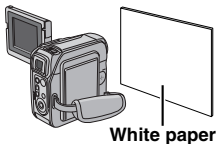

Wipe Or Fader Effects

These effects let you make pro-style scene transitions. Use them to spice up the transition from one scene to the next.

Wipe or Fader works when video recording is started or stopped.

1 Set the **VIDEO/MEMORY** Switch to "VIDEO".

2 Set the Power Switch to "M".

3 Set "☒" to the desired mode. (☞ pg. 27)

- The WIPE/FADER menu disappears and the effect is reserved.
- The selected effect indicator appears.

4 Press the Recording Start/Stop Button to activate the Fade-in/out or Wipe-in/out.

To deactivate the selected effect

Select "OFF" in step **3**. The effect indicator disappears.

NOTES:

- You can extend the length of a Wipe or Fader by pressing and holding the Recording Start/Stop Button.
- Some Wipe/Fader Effects cannot be used with certain modes of Program AE with special effects. (☞ pg. 35) In this case, the selected indicator blinks or goes out.

☒ WIPE/FADER

OFF: Disables the function. (Factory-preset)

☒ **FADER-WHITE**: Fade in or out with a white screen.

☒ **FADER-BLACK**: Fade in or out with a black screen.

☒ **FADER-B.W**: Fade in to a color screen from a black and white screen, or fade out from color to black and white.

☒ **WIPE-CORNER**: Wipe in on a black screen from the upper right to the lower left corner, or wipe out from lower left to upper right, leaving a black screen.

☒ **WIPE-WINDOW**: The scene starts in the center of a black screen and wipes in toward the corners, or comes in from the corners, gradually wiping out to the center.

☒ **WIPE-SLIDE**: Wipe in from right to left, or wipe out from left to right.

☒ **WIPE-DOOR**: Wipe in as the two halves of a black screen open to the left and right, revealing the scene, or wipe out and the black screen reappears from left and right to cover the scene.

☒ **WIPE-SCROLL**: The scene wipes in from the bottom to the top of a black screen, or wipes out from top to bottom, leaving a black screen.

☒ **WIPE-SHUTTER**: Wipe in from the center of a black screen toward the top and bottom, or wipe out from the top and bottom toward the center leaving a black screen.

Program AE With Special Effects

- 1 Set the Power Switch to "M".
- 2 Set "AE" to the desired mode. (⇨ pg. 27)
 - The PROGRAM AE menu disappears and the selected effect is activated.
 - The selected effect indicator appears.

To deactivate the selected effect
Select "OFF" in step 2. The effect indicator disappears.

NOTES:

- Program AE with special effects can be changed during recording or during Record-Standby.
- Some modes of Program AE with special effects cannot be used during Night-Alive.
- When a subject is too bright or reflective, a vertical streak may appear (smear phenomenon). Smear phenomenon tends to occur when "SPORTS" or any mode of "SHUTTER 1/250 – 1/4000" is selected.
- Some modes of Program AE with special effects cannot be used with certain Wipe/Fader effects. (⇨ pg. 34) In this case, the selected indicator blinks or goes out.

PROGRAM AE

OFF: Disables the function. (Factory-preset)

1/60 SHUTTER 1/60: The shutter speed is fixed at 1/60th of a second. Black bands that usually appear when shooting a TV screen become narrower.

1/100 SHUTTER 1/100: The shutter speed is fixed at 1/100th of a second. The flickering that occurs when shooting under a fluorescent light or mercury-vapor lamp is reduced.

SHUTTER 1/250/ SHUTTER 1/500/ SHUTTER 1/1000*/ SHUTTER 1/2000*/ SHUTTER 1/4000*: These settings allow fast-moving images to be captured one frame at a time, for vivid, stable slow-motion playback by fixing shutter speed variables. Use these settings when an automatic adjustment does not work well, using **SPORTS** mode. The faster the shutter speed, the darker the picture becomes. Use the shutter function under good lighting conditions.

SPORTS

(Variable Shutter Speed: 1/250 – 1/4000):

This setting allows fast-moving images to be captured one frame at a time, for vivid, stable slow-motion playback. The faster the shutter speed, the darker the picture becomes. Use the shutter function under good lighting conditions.

 **SNOW:** Compensates for subjects that may otherwise appear too dark when shooting in extremely bright surroundings such as in the snow.

 **SPOTLIGHT:** Compensates for subjects that may otherwise appear too bright when shooting under extremely strong direct lighting such as spotlights.

 **TWILIGHT:** Makes evening scenes look more natural. White Balance (⇨ pg. 34) is automatically set to "☀️", but can be changed to your desired setting. When Twilight is chosen, the camcorder automatically adjusts the focus from approx. 10 m (32 ft) to infinity. From less than 10 m, adjust the focus manually.

 **SEPIA:** Recorded scenes have a brownish tint like old photos. Combine this with the Cinema mode for a classic look.

B/W MONOTONE: Like classic black and white films, your footage is shot in B/W. Used together with the Cinema mode, it enhances the "classic film" effect.

 **CLASSIC FILM*:** Gives recorded scenes a strobe effect.

 **STROBE*:** Your recording looks like a series of consecutive snapshots.

 **MIRROR*:** Creates a mirror image on the right half of the screen, juxtaposed to the normal image on the other half.

* Available only when the **VIDEO/MEMORY** Switch is set to "VIDEO".

Navigation Function

The Navigation Function helps you check tape contents by making thumbnail images on a memory card.

Before continuing

To use Navigation functions, load a cassette and memory card, then set the **VIDEO/MEMORY** Switch to "VIDEO".

To make thumbnail images during video recording automatically

1 Set "NAVIGATION" to the desired navigation storing time. (⇨ pg. 27, 28)

- If the "NAVIGATION" indicator appears blinking on the screen, wait until it stops blinking. If it does not stop blinking after a while, check if a memory card is loaded.

2 Set the Power Switch to "A" or "M".

3 Press the Recording Start/Stop Button to start recording.

- When the recording time is over the navigation time set in step 1, "NAVIGATION" appears briefly, then the image of the point where recording is started is captured and stored in the memory card as a thumbnail image.

- If the Recording Start/Stop button is pressed before "NAVIGATION" stops blinking, the image of the point where the loaded memory card is recognized is captured.

4 Press the Recording Start/Stop Button to stop recording.

To make thumbnail images after video recording manually

- 1 Set "NAVIGATION" to "MANUAL". (☞ pg. 27, 28)
- 2 Set the Power Switch to "A" or "M".
- 3 After the recording, press **NAVI STORE**.
 - The "NAV" indicator appears briefly and the captured image is stored in the memory card as a thumbnail image.

NOTES:

- The remaining number of storable thumbnail images also appears on the screen when it reaches 10 or less. If "REC SELECT" is set to "▶▶ [M]" in DSC Menu, the number shows how many 640 x 480 pixel images can be stored.
- If "5S" is set to "5S" or "Anim." in MANUAL Menu, the NAVIGATION function will not work properly.

To find scenes on tape using thumbnail images (Navigation Search)

- 1 Set the Power Switch to "PLAY".
- 2 Press **NAVI** during video playback or stop mode.
 - The loaded cassette's Navigation thumbnail image screen appears.
- 3 Press </>/^/∨ to select the desired image, and press **SET**.
 - The "NAVIGATION SEARCH" indication appears blinking and the camcorder starts searching the tape for the relevant point of the selected thumbnail image.



To cancel Navigation search midway

Press ▶/II, ◀◀, ▶▶ or ■.

To add thumbnail images during video playback

- 1 Set the Power Switch to "PLAY".
- 2 Press ▶/II to start video playback.
- 3 Press **NAVI STORE** at the desired point.
 - The "NAV" indicator appears briefly and the image of the point where **NAVI STORE** is pressed is stored in the memory card as a thumbnail image.

To delete thumbnail images

- 1 Set the Power Switch to "PLAY".
- 2 Press **MENU**. The Menu Screen appears.
- 3 Press **SET** to select "DEL". The VIDEO Menu appears.
- 4 Press **SET** to select "NAVI.DEL.", and press **SET**. The Sub Menu appears.
- 5 By pressing ^ or ∨:
 - Select "IMAGE SEL." to delete the currently displayed thumbnail image.
 - Select "TAPE SEL." to delete all thumbnail images for the tape which contains the currently displayed image.
 - Select "ALL" to delete all thumbnail images stored in the memory card at once.

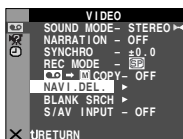

- 6 Press **SET**. The NAVIGATION screen appears.

- 7 Press ^ or ∨ to select "EXECUTE", and press **SET**.

- Press < to display the previous image. Press > to display the next image.
- To cancel deletion, select "RETURN".
- Thumbnail images cannot be deleted during video playback.

CAUTION:

Do not remove the memory card or perform any other operation (such as turning off the camcorder) during deletion. Also, be sure to use the provided AC Adapter, as the memory card may be corrupted if the battery becomes exhausted during deletion. If the memory card becomes corrupted, initialize it.

NOTES:

- Be sure to always use the same tape and memory card together as they were during recording; otherwise, the camcorder cannot recognize Tape and Memory Card IDs to perform Navigation Function properly.
- Check if an appropriate tape and memory card are loaded when the following messages appear: "UNABLE TO USE NAVIGATION", "THIS MEMORY CARD IS NOT COMPATIBLE".
- If you change the memory card while shooting on one tape, two memory cards will share the tape's thumbnail images. We recommend that you use one memory card for one tape.
- Navigation Search does not work if the current position is at a blank portion on the tape. Also, do not leave a blank portion partway through the tape when shooting; otherwise, Navigation Function does not work properly.
- Before shooting newly over a recorded tape, be sure to delete all thumbnail images of the previous recording from the relevant memory card.
- If you copy thumbnail images from one memory card to another via a PC, Navigation Search does not work with the copied memory card.



Dubbing To Or From A VCR

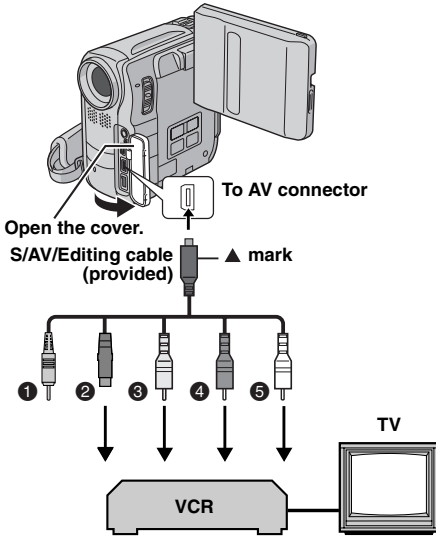

- ❶ Remote plug: Not connected (When not in use, keep the Remote plug in its protective caddy.)
 - ❷ To S-VIDEO IN or OUT*
 - ❸ Yellow to VIDEO IN or OUT
 - ❹ Red to AUDIO R IN or OUT
 - ❺ White to AUDIO L IN or OUT
- * Connect when your TV/VCR has an S-VIDEO IN/OUT connector. In this case, it is not necessary to connect the yellow video cable.

To use this camcorder as a player

- ❶ Following the illustrations, connect the camcorder and the VCR's input connectors.
- ❷ Start playback on the camcorder. (☞ pg. 17)
- ❸ At the point you want to start dubbing, start recording on the VCR. (Refer to the VCR's instruction manual.)
- ❹ To stop dubbing, stop recording on the VCR, then stop playback on the camcorder.

NOTES:

- It is recommended to use the AC Adapter as the power supply instead of the battery pack. (☞ pg. 11)
- To choose whether or not the following displays appear on the connected TV
 - Date/time
Set "DATE/TIME" to "AUTO", "ON" or "OFF". (☞ pg. 27, 31) Or, press **DISPLAY** on the remote control to turn on/off the date indication.
 - Time code
Set "TIME CODE" to "OFF" or "ON". (☞ pg. 27, 31)
 - Indications other than date/time and time code
Set "ON SCREEN" to "OFF", "LCD" or "LCD/TV". (☞ pg. 27, 31)

To use this camcorder as a recorder

- ❶ Following the illustrations, connect the camcorder and the VCR's output connectors.
 - ❷ Set "REC MODE" to "SP" or "LP". (☞ pg. 27, 28)
 - ❸ Set the camcorder's Power Switch to "PLAY".
 - ❹ Set "S/AV INPUT" to "A/V.IN" or "S.IN"*.
(☞ pg. 27, 30)
- * Select "S.IN" when using S-VIDEO OUT connector on your TV/VCR.
- ❺ Press the Recording Start/Stop Button to engage the Record-Pause mode.
 - The "A/V.IN" or "S.IN" indication appears on the screen.
 - ❻ Start playback on the player.
 - ❼ At the point you want to start dubbing, press the Recording Start/Stop Button to start dubbing. The ⏸ indication rotates.
 - ❽ Press the Recording Start/Stop Button again to stop dubbing. The ⏸ indication stops rotating.
 - ❾ Press ■ to return to the normal playback mode.

NOTES:

- After dubbing, set "S/AV INPUT" back to "OFF".
- Analog signals can be converted to digital signals with this procedure.
- It is also possible to dub from another camcorder.

Dubbing To Or From A Video Unit Equipped With A DV Connector (Digital Dubbing)

It is also possible to copy recorded scenes from the camcorder onto another video unit equipped with a DV connector. Since a digital signal is sent, there is little if any image or sound deterioration.

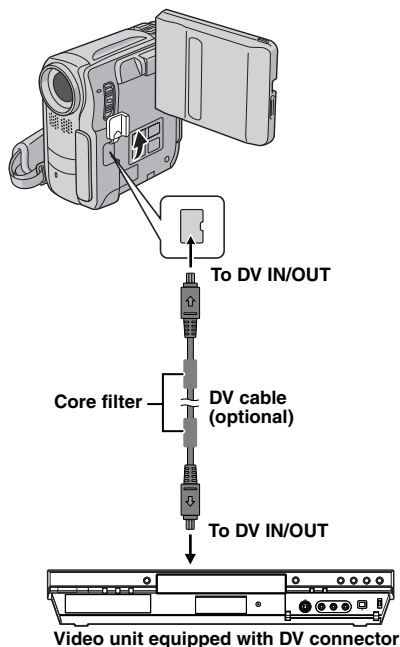



To use this camcorder as a player

- 1 Make sure all units are turned off.
- 2 Connect this camcorder to a video unit equipped with a DV input connector using a DV cable as shown in the illustration.
- 3 Start playback on the camcorder. (☞ pg. 17)
- 4 At the point you want to start dubbing, start recording on the video unit. (Refer to the video unit's instruction manual.)
- 5 To stop dubbing, stop recording on the video unit, then stop playback on this camcorder.

NOTES:

- It is recommended to use the AC Adapter as the power supply instead of the battery pack. (☞ pg. 11)
- If a blank portion or disturbed image is played back on the player during dubbing, the dubbing may stop so that an unusual image is not dubbed.
- Even though the DV cable is connected correctly, sometimes the image may not appear in step 4. If this occurs, turn off the power and make connections again.
- If "Playback Zoom" (☞ pg. 20) or "Playback Special Effects" (☞ pg. 20) is attempted or **SNAPSHOT** is pressed during playback, only the original playback image recorded on the tape is output from the DV IN/OUT connector.
- When using a DV cable, be sure to use the optional JVC VC-VDV204U DV cable.

To use this camcorder as a recorder

- 1 Make sure all units are turned off.
- 2 Connect this camcorder to a video unit equipped with a DV output connector using a DV cable as shown in the illustration.
- 3 Set "REC MODE" to "SP" or "LP". (☞ pg. 27, 28)
- 4 Set the camcorder's Power Switch to "PLAY".
- 5 Press the Recording Start/Stop Button to engage the Record-Pause mode.
 - The "DV.IN" indication appears on the screen.
- 6 Start playback on the player.
- 7 At the point you want to start dubbing, press the Recording Start/Stop Button to start dubbing. The  indication rotates.
- 8 Press the Recording Start/Stop Button again to stop dubbing. The  indication stops rotating.
- 9 Press  to return to the normal playback mode.

NOTES:

- If no image is displayed on the LCD monitor, set "S/AV INPUT" to "OFF". (☞ pg. 27, 30)
- Digital Dubbing is performed in the sound mode recorded on the original tape, regardless of the current "SOUND MODE" setting. (☞ pg. 28)

Connection To A Personal Computer

[A] Using USB cable

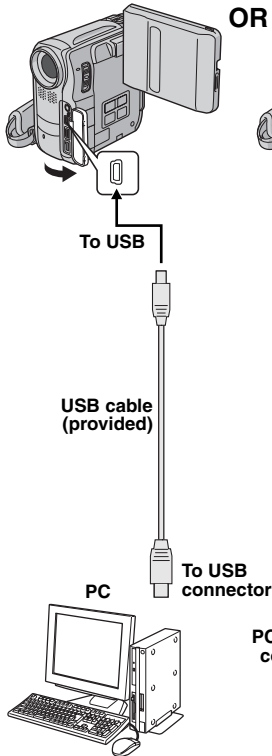

[B] Using DV cable

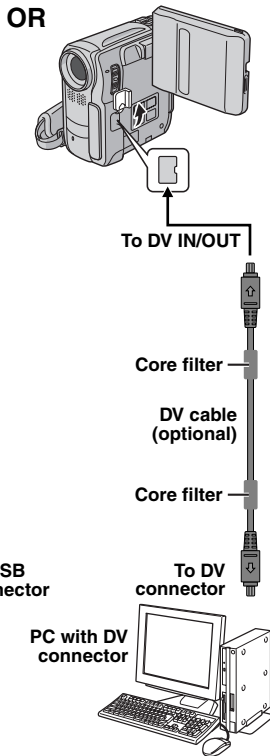

[A] Using USB cable

It is possible to do the following things:

- Transfer still images stored on a memory card to a PC.
- Transfer still/moving images recorded on a tape to a PC.
- Capture still/moving images in real-time.
- Use this camcorder as a WebCam.

[B] Using DV cable

It is also possible to transfer still/moving images to a PC with a DV connector by using the provided software, software equipped with the PC or commercially available software.

NOTES:

- Refer to "SOFTWARE INSTALLATION AND USB CONNECTION GUIDE" for the installation of the bundled software and drivers.
- The software operation manual is provided as PDF file on the CD-ROM.
- It is recommended to use the AC Adapter as the power supply instead of the battery pack. (pg. 11)
- **Never connect the USB cable and the DV cable simultaneously to the camcorder. Connect only the cable you wish to use to the camcorder.**
- **When using a DV cable, be sure to use the optional JVC VC-VDV206U or VC-VDV204U DV cable depending on the type of DV connector (4 or 6 pins) on the PC.**
- If the PC connected to the camcorder via the USB cable is not powered, the camcorder does not enter the USB mode.
- The date/time information cannot be captured into the PC.
- Refer to the instruction manuals of the PC and Software.
- The still images can also be transferred to a PC with a DV connector-equipped capture board.
- The system may not work properly depending on the PC or capture board you are using.

When connecting the camcorder to a PC using a DV cable, make sure to follow the procedure below. Connecting the cable incorrectly may cause malfunctions to the camcorder and/or the PC.

- Connect the DV cable first to the PC, and then to the camcorder.
- Connect the DV cable (plugs) correctly according to the shape of the DV connector.

"USB MODE" and/or "ACCESSING FILES" appears on the LCD monitor while the PC is accessing data in the camcorder or the camcorder is transferring a file to the PC.

NEVER disconnect the USB cable while "ACCESSING FILES" is displayed on the LCD monitor since this can result in product damage.

Audio Dubbing

The audio track can be customized only when recorded in the 12-BIT and SP modes. (☞ pg. 28)

- Use the provided remote control or an optional remote control kit RM-V717KITU.

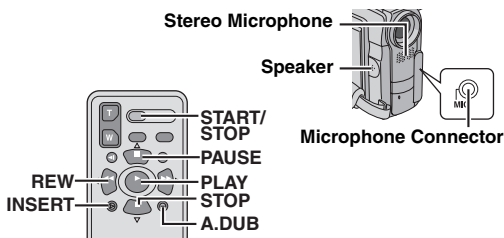

1 Play back the tape to locate the point where editing will start, then press **PAUSE (II)**.

2 While holding **A. DUB (⊖)** on the remote control, press **PAUSE (II)**. The “**II**” and “**MIC**” indicators appear.

3 Press **PLAY (▶)**, then begin “narrating”. Speak into the microphone.

- To pause dubbing, press **PAUSE (II)**.

4 To end Audio Dubbing, press **PAUSE (II)**, then **STOP (■)**.

To hear the dubbed sound during playback

Set “**NARRATION**” to “**ON**” or “**MIX**”. (☞ pg. 27, 30)

NOTES:

- Sound is not heard from the speaker during Audio Dubbing.
- When editing onto a tape that was recorded at 12-BIT, the old and new soundtracks are recorded separately.
- If you dub onto a blank space on the tape, the sound may be disrupted. Make sure you only edit recorded areas.
- If feedback or howling occurs during TV playback, move the camcorder’s microphone away from the TV, or turn down the TV’s volume.
- If you change from 12-BIT to 16-BIT in mid-recording and then use the tape for Audio Dubbing, it is not effective from the point where 16-BIT recording began.
- During Audio Dubbing, when the tape moves to scenes recorded in the LP mode, scenes recorded in 16-BIT audio or a blank portion, Audio Dubbing stops.
- Audio dubbing is also possible using an optional microphone connected to the MIC connector.
- While an optional microphone is connected, the built-in microphone is disabled.
- To perform Audio Dubbing with a video unit connected to the camcorder’s AV connector, first set “**S/AV INPUT**” to “**A/V.IN**” or “**S.IN**” in **VIDEO Menu**. (☞ pg. 27, 30)
The “**AUX**” indication appears instead of “**MIC**”.

Insert Editing

You can record a new scene into a previously recorded tape, replacing a section of the original recording with minimal picture distortion at the in and outpoints. The original audio remains unchanged.

- Use the provided remote control or an optional remote control kit RM-V717KITU.

NOTES:

- Before performing the following steps, make sure that “**TIME CODE**” is set to “**ON**”. (☞ pg. 27, 31)
- Insert Editing is not possible on a tape recorded in the LP mode or on a blank portion of a tape.

1 Play back the tape, locate the Edit-Out point and press **PAUSE (II)**. Confirm the time code at this point. (☞ pg. 17)

2 Press **REW (◀)** until the Edit-In point is located, then press **PAUSE (II)**.

3 Press and hold **INSERT (Ⓞ)** on the remote control, then press **PAUSE (II)**. The “**II**” indicator and the Time Code (min.:sec.) appear and the camcorder enters Insert-Pause mode.

4 Press **START/STOP** to begin editing.

- Confirm the insert at the time code you checked in step **1**.
- To pause editing, press **START/STOP**. Press it again to resume editing.

5 To end Insert Editing, press **START/STOP**, then **STOP (■)**.

NOTES:

- Program AE with special effects (☞ pg. 35) can be used to spice up the scenes being edited during Insert Editing.
- During Insert Editing, the date and time information changes.
- If you perform Insert Editing onto a blank space on the tape, the audio and video may be disrupted. Make sure you only edit recorded areas.
- During Insert Editing, when the tape moves to scenes recorded in the LP mode or a blank portion, Insert Editing stops. (☞ pg. 47)

Random Assemble Editing [R.A.Edit]

Create edited videos easily using your camcorder as the source player. You can select up to 8 "cuts" for automatic editing, in any order you like. R.A.Edit is more easily performed when the MBR (Multi-Brand Remote) is set to operate with your brand of VCR (see "VCR CODE LIST"), but can also be performed by operating the VCR manually.

- Use the optional remote control kit RM-V717KITU. It is a set composed of RM-V717U remote control, an Editing cable* and an Editing extension cable.

* The Editing cable is not required with this camcorder.

- Refer to remote control kit's instructions as well.

Set Remote/VCR Code

1 Turn off the power to the VCR and point the remote towards the VCR's infrared sensor. Then, referring to the VCR CODE LIST, press and hold **MBR SET**, and enter the brand code. The code is automatically set once you release **MBR SET**, and the VCR's power comes on.

2 Make sure the VCR's power is on. Then, while holding **SHIFT**, press the button on the remote for the desired function. The functions the remote can control are **PLAY** (▶), **STOP** (■), **PAUSE** (II), **FF** (▶▶), **REW** (◀◀) and **VCR REC STBY** (●II; you do not need to press **SHIFT** for this one).

You are now ready to try Random Assemble Editing.

IMPORTANT:

Although the MBR is compatible with JVC VCRs and those of many other makers, it may not work with yours or may offer limited functions.

NOTES:

- If the VCR's power does not come on in step 1, try another code from the VCR CODE LIST.
- Some brands of VCR do not come on automatically. In this case, turn the power on manually and try step 2.
- If the remote control is not able to control the VCR, use the controls on the VCR.
- When the remote control's batteries run out, the VCR brand you have set will be erased. In that case, replace the old battery with a new one to reset the VCR brand.

VCR CODE LIST

BRAND NAME	CODE
DAEWOO	18
GE	11, 92, 90, 94
HITACHI	66, 63
JVC A JVC B JVC C	91 96 93
LG/GOLDSTAR	11
MAGNAVOX	95, 11, 71, 76
MITSUBISHI	67, 68
NEC	37, 38
PHILIPS	19, 95, 11, 94, 91, 96, 12, 33, 72
PANASONIC	13, 17, 11, 94, 18
RCA	92, 94, 66, 63, 90
SAMSUNG	94
SANYO	36, 35
SHARP	15, 10
SONY	65, 60, 39, 31
TOSHIBA	69, 61
ZENITH	16

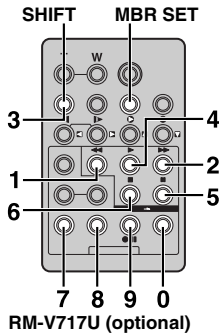

Buttons And Functions (RM-V717U)

- 1 Infrared beam transmitting window
Transmits the beam signal.
- 2 DISPLAY Button*
- 3 SHIFT Button (see the left column)
- 4 SLOW Rewind/Forward Buttons*
Left/Right Buttons*
- 5 REW Button*
- 6 FADE/WIPE Button (☞ pg. 43)
- 7 EFFECT ON/OFF Button*
- 8 EFFECT Button*
- 9 PAUSE IN Connector (☞ pg. 42)
- 10 MBR SET Button (see the left column)
- 11 Up Button*
INSERT Button*
- 12 Down Button*
A. DUB Button*
- 13 PLAY Button*
- 14 FF Button*
- 15 STOP Button*
- 16 PAUSE Button*
- 17 R.A.EDIT Buttons
(☞ pg. 43, 44)
- 18 Zoom (T/W) Buttons*
- 19 START/STOP Button*
- 20 SNAPSHOT Button*

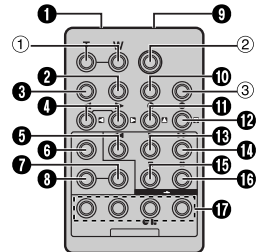

* Functions the same as each corresponding button on the provided remote control RM-V720U (☞ pg. 19)

Make Connections

Also refer to page 18.

1 **A JVC VCR equipped with a Remote PAUSE connector**

Connect the editing cable to the Remote PAUSE connector.

2 **A JVC VCR not equipped with a Remote PAUSE connector but equipped with an R.A.EDIT connector**

Connect the editing cable to the R.A.EDIT connector.

3 **A VCR other than above**

Connect the editing cable to the remote control's PAUSE IN connector.

2 Insert a recorded tape into the camcorder.

3 Set the **VIDEO/MEMORY** Switch to "VIDEO".

4 Set the Power Switch to "PLAY" while pressing down the Lock Button located on the switch.

5 Turn the VCR power on, insert a recordable tape and engage the AUX mode.

- Refer to the VCR's instructions.

NOTES:

- Before Random Assemble Editing, make sure the indications do not appear on the TV monitor. If they do, they will be recorded onto the new tape.

To choose whether or not the following displays appear on the connected TV

- Date/time
Set "DATE/TIME" to "AUTO", "ON" or "OFF". (pg. 27, 31) Or, press **DISPLAY** on the remote control to turn on/off the date indication.
- Time code
Set "TIME CODE" to "OFF" or "ON". (pg. 27, 31)
- Indications other than date/time and time code
Set "ON SCREEN" to "OFF", "LCD" or "LCD/TV". (pg. 27, 31)
- When editing on a VCR equipped with a DV input connector, an optional DV cable can be connected instead of the S/AV/Editing cable. However, it is necessary to connect the editing cable of the S/AV/Editing cable to the VCR. (For details, see step 1.)

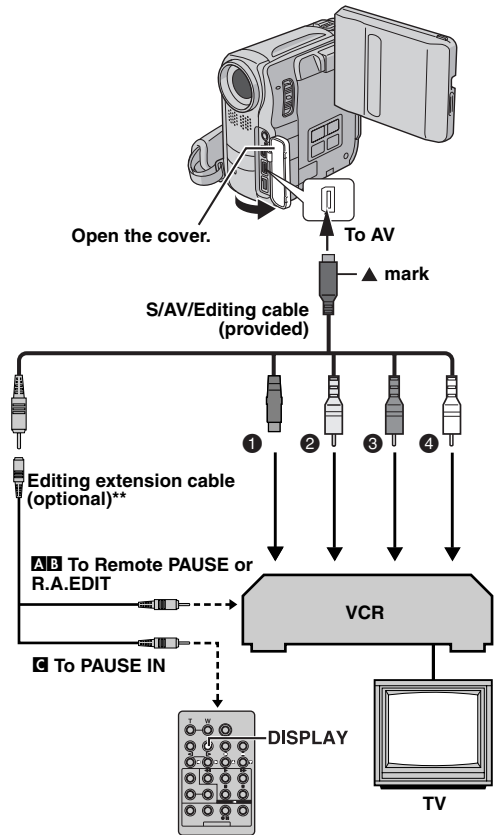

1 Black to S-VIDEO IN*

2 Yellow to VIDEO IN

3 Red to AUDIO R IN

4 White to AUDIO L IN

* Connect when your TV/VCR has an S-VIDEO IN connector. In this case, it is not necessary to connect the yellow video cable.

** If necessary, use this cable provided with the remote control kit RM-V717KITU for connections.

Select Scenes

RM-V717U (optional)

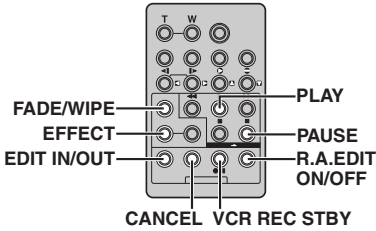

6 Press **PLAY** (▶) and then press **R.A.EDIT ON/OFF** on the remote control.

- The Random Assemble Editing Menu appears.

7 If using a Wipe/Fader at the beginning of the scene, press **FADE/WIPE** on the remote control.

- Cycle through the effects by pressing repeatedly, and stop when the one you want is displayed.

- You cannot use a Picture Wipe/Dissolve at the beginning of Program 1.

8 At the beginning of the scene, press **EDIT IN/OUT** on the remote control. The Edit-In position appears in the Random Assemble Editing Menu.

9 At the end of the scene, press **EDIT IN/OUT**. The Edit-Out position appears in the Random Assemble Editing Menu.

10 If using a Wipe/Fader at the end of the scene, press **FADE/WIPE**.

- Cycle through the effects by pressing repeatedly, and stop when the one you want is displayed.
- If you select a Wipe/Fader effect for an Edit-Out point, the effect is automatically applied to the following Edit-In point.
- You cannot use a Picture Wipe/Dissolve at the end of the last scene.
- When you use Fader/Wipe effects, that time is included in the total time (this does not apply to Picture Wipe/Dissolve).

11 If using Playback Special Effects, press **EFFECT**. (pg. 20)

12 Repeat steps **8** through **11** to register additional scenes.

- To change previously registered points, press **CANCEL** on the remote control. The registered points disappear, one at a time, from the most recently registered point.
- If you are not using Wipe/Fader or Program AE with special effects, repeat steps **8** and **9** only.

NOTES:

- When choosing a scene, set Edit-In and Edit-Out points so that there is a relatively large difference between them.
- If the search time for an in-point exceeds 5 minutes, the recording deck's Record-Standby mode will be cancelled and editing will not take place.
- If there are blank portions before or after the Edit-In and Edit-Out points, a blue screen may be included in the edited version.
- Turning off the camcorder's power erases all registered Edit-In and Edit-Out points.
- If you select Sepia or Monotone mode from Program AE with special effects, you cannot use the Dissolve or Black & White Fader. In this case the Dissolve or Black & White indicator begins blinking. Once the next Edit-In point is registered, the effect is turned off. To combine these effects, use Sepia or Monotone during recording, then use the Dissolve or Black & White Fader during Random Assemble Editing.
- It is not possible to use Wipe/Fader effects and Program AE with special effects during Random Assemble Editing using a DV cable.

Selected parameter

	IN	OUT	MODE
1	---	---	---
2	---	---	---
3	---	---	---
4	---	---	---
5	---	---	---
6	---	---	---
7	---	---	---
8	---	---	---
TIME CODE			---
TOTAL			00:00

Picture Wipe And Dissolve Menu (available only for Random Assemble Editing)

You can use not only the wipe/fader effects on page 34 but also the picture wipe and dissolve effects below.

P DISSOLVE: The new scene gradually appears as the old one gradually disappears.

P WIPE-CORNER: The new scene wipes in over the previous one from the upper right corner to the lower left corner.

P WIPE-WINDOW: The next scene gradually wipes in from the center of the screen toward the corners, covering the previous scene.

P WIPE-SLIDE: The next scene gradually wipes in over the previous one from right to left.

P WIPE-DOOR: The previous scene wipes out from the center to the right and left, like a door being pushed open to reveal the next scene.

P WIPE-SCROLL: The new scene wipes in over the last one from the bottom of the screen to the top.

P WIPE-SHUTTER: The new scene wipes in over the previous one from the center toward the top and bottom of the screen.

Automatic Editing To VCR

13 Rewind the tape in the camcorder to the beginning of the scene you want to edit and press **PAUSE (II)**.

14 Press **VCR REC STBY (●II)** on the remote control, or manually engage the VCR's Record-Pause mode.

15 Press the Recording Start/Stop Button on the camcorder. Editing proceeds as programmed, right through to the end of the last registered scene.

- When dubbing is complete, the camcorder enters the Pause mode, and the VCR enters its Record-Pause mode.
- If you do not register an Edit-Out point, the tape will be dubbed all the way to the end automatically.
- If you operate the camcorder during automatic editing, the VCR will enter its Record-Pause mode and automatic editing will stop.

16 Engage the Stop modes for the camcorder and the VCR.

- To make the R.A.Edit counter display disappear, press **R.A.EDIT ON/OFF** on the remote control.

NOTES:

- Pressing **R.A.EDIT ON/OFF** on the remote control clears all settings registered during Random Assemble Editing.
- When the editing cable is connected to the remote control's PAUSE IN connector during dubbing, make sure the remote control is pointed at the VCR's sensor, and the path between the two is unobstructed.
- Random Assemble Editing may not function properly when using a tape including several duplicated time codes. (☞ pg. 17)

For More Accurate Editing

Some VCRs make the transition from Record-Pause to Record mode faster than others. Even if you begin editing for the camcorder and the VCR at exactly the same time, you may lose scenes you wanted, or find that you have recorded scenes you did not want. For a cleanly edited tape, confirm and adjust the timing of the camcorder against your VCR.

Diagnosing VCR/Camcorder Timing

1 Play back the tape in the camcorder, then point the remote control at the camcorder's remote sensor and press **R.A.EDIT ON/OFF**.

- Random Assemble Editing Menu appears.

2 Perform Random Assemble Editing on Program 1 only. In order to check VCR and camcorder timing, select the beginning of a scene transition as your Edit-In point.

3 Play back the dubbed scene.

- If any images from the scene prior to the transition you chose for your Edit-In point were recorded, that means your VCR moves too quickly from Record-Pause to Record mode.
- If the scene you tried to dub starts in progress, the VCR is slow to start recording.

Program 1

	IN	OUT	MODE
1	---	---	---
2	-	-	-
3	-	-	-
4	-	-	-
5	-	-	-
6	-	-	-
7	-	-	-
8	-	-	-

TIME CODE --:--
TOTAL 00:00

Adjustment Of VCR/Camcorder Timing

4 Press **R.A.EDIT ON/OFF** to make the Random Assemble Editing menu disappear, then press **MENU**. The Menu Screen appears.

5 Press **SET** to select "VID". The VIDEO Menu appears.

6 Press \wedge or \vee to select "SYNCHRO", and press **SET**. The value for "SYNCHRO" is highlighted. (Factory-preset: ± 0.0)

7 Based on the diagnostics performed, you can now advance the VCR's record timing by pressing \wedge . You can also delay the VCR's record timing by pressing \vee .
• The adjustment range is from -1.3 to $+1.3$ seconds, in 0.1 -second increments.

Press **SET** to finish the setting.

8 Press \wedge or \vee to select "URETURN", and press **SET** twice.

- Now perform Random Assemble Editing beginning with step **6** on page 43.

NOTES:

- Before performing actual Random Assemble Editing, do a few Random Assemble Editing trial runs to check whether the value you have input is appropriate or not, and make adjustments accordingly.
- Depending on the recorder, there may be situations where the timing difference cannot be fully corrected.

If, after following the steps in the chart below, the problem still exists, please consult your nearest JVC dealer.

The camcorder is a microcomputer-controlled device. External noise and interference (from a TV, a radio, etc.) might prevent it from functioning properly. In such cases, first disconnect its power supply unit (battery pack, AC Adapter, etc.) and wait a few minutes; and then re-connect it and proceed as usual from the beginning.

Power

No power is supplied.

- The power is not connected properly.
- Connect the AC Adapter securely. (☞ pg. 11)
- The battery pack is not attached firmly.
- Detach the battery pack once again and re-attach it firmly. (☞ pg. 11)
- The battery is dead.
- Replace the dead battery with a fully charged one. (☞ pg. 11)

Video and D.S.C. Recording

Recording cannot be performed.

- The tape's erase protection tab is set to "SAVE".
- Set the tape's erase protection tab to "REC". (☞ pg. 14)
- "TAPE END" appears.
- Replace with new cassette. (☞ pg. 14)
- The cassette holder cover is open.
- Close the cassette holder cover.

When shooting a subject illuminated by bright light, vertical lines appear.

- This is not a malfunction.

When the screen is under direct sunlight during shooting, the screen becomes red or black for an instant.

- This is not a malfunction.

During recording, the date/ time does not appear.

- "DATE/TIME" is set to "OFF".
- Set "DATE/TIME" to "ON". (☞ pg. 27, 29)

The LCD monitor or viewfinder indications blink.

- Certain Wipe/Fader effects, certain modes of Program AE with special effects, "DIS" and other functions that cannot be used together are selected at the same time.
- Re-read the sections covering Wipe/Fader effects, Program AE with special effects and "DIS". (☞ pg. 27, 28, 34, 35)

Digital Zoom does not work.

- 10X optical zoom is selected.
- Set "ZOOM" to "40X" or "500X". (☞ pg. 28)
- The VIDEO/MEMORY Switch is set to "MEMORY".
- Set the VIDEO/MEMORY Switch to "VIDEO".

Video and D.S.C. Playback

The tape is moving, but there is no picture.

- Your TV has AV input terminals, but is not set to its VIDEO mode.
- Set the TV to the mode or channel appropriate for video playback. (☞ pg. 18)
- The cassette holder cover is open.
- Close the cassette holder cover. (☞ pg. 14)

Blocks of noise appear during playback, or there is no playback picture and the screen becomes blue.

- Clean the video heads with an optional cleaning cassette. (☞ pg. 50)

Advanced features

The focus does not adjust automatically.

- Focus is set to the Manual mode.
- Set Focus to the Auto mode. (☞ pg. 32)
- The lens is dirty or covered with condensation.
- Clean the lens and check the focus again. (☞ pg. 48)

In the 5-Second mode, recording ends before 5 seconds have elapsed.

- The 5-Second mode is set to "Anim." in MANUAL Menu.
- Set "5S" to "5S" in MANUAL Menu. (☞ pg. 27, 32)

Snapshot mode cannot be used.

- The Squeeze mode (SQUEEZE) is selected.
- Disengage the Squeeze (SQUEEZE) mode. (☞ pg. 27, 29)

The color of Snapshot looks strange.

- The light source or the subject does not include white. Or there are various different light sources behind the subject.
- Find a white subject and compose your shot so that it also appears in the frame. (☞ pg. 21, 32)

The image taken using Snapshot is too dark.

- Shooting was performed under backlit conditions.
- Press **BACK LIGHT**. (☞ pg. 33)

The image taken using Snapshot is too bright.

- The subject is too bright.
- Set "SP" to "SPOTLIGHT". (☞ pg. 35)

White Balance cannot be activated.

- The Sepia (SEPIA) or Monotone (MONOTONE) mode is activated.
- Disengage the Sepia (SEPIA) or Monotone (MONOTONE) mode before setting White Balance. (☞ pg. 35)

The Black & White Fader does not work.

- The Sepia (SEPIA) or Monotone (MONOTONE) mode is activated.
- Disengage the Sepia (SEPIA) and Monotone (MONOTONE). (☞ pg. 27, 35)

The image looks like the shutter speed is too slow.

- When shooting in the dark, the unit becomes highly sensitive to light when "GAIN UP" is set to "AUTO".
- If you want the lighting to look more natural, set "GAIN UP" to "AGC" or "OFF". (☞ pg. 27, 28)

Other problems**The POWER/CHARGE lamp on the camcorder does not light during charging.**

- Charging is difficult in places subject to extremely high/low temperatures.
- To protect the battery, it is recommended to charge it in places with a temperature of 10°C to 35°C (50°F to 95°F). (☞ pg. 49)
- The battery pack is not attached firmly.
- Detach the battery pack once again and re-attach it firmly. (☞ pg. 11)

“SET DATE/TIME!” appears.

- The built-in clock's rechargeable lithium battery is discharged.
- The previously set date/time is erased.
- Connect the camcorder to an AC outlet using the AC Adapter for over 24 hours to charge the clock's lithium battery. (☞ pg. 12)

Files stored in the memory card cannot be deleted.

- Files stored in the memory card are protected.
- Remove protection from the files stored in the memory card and delete them. (☞ pg. 25)

When the image is printed from the printer, a black bar appears at the bottom of the screen.

- This is not a malfunction.
- By recording with “DIS” activated (☞ pg. 27, 28) this can be avoided.

When the camcorder is connected via the DV connector, the camcorder does not operate.

- The DV cable was plugged/unplugged with power turned on.
- Turn the camcorder's power off and on again, then operate it.

Images on the LCD monitor appear dark or whitish.

- In places subject to low temperature, images become dark due to the characteristics of the LCD monitor. This is not a malfunction.
- Adjust the brightness and angle of the LCD monitor. (☞ pg. 13, 15)
- When the LCD monitor's fluorescent light reaches the end of its service life, images on the LCD monitor become dark.
- Consult your nearest JVC dealer.

Colored bright spots appear all over the LCD monitor or the viewfinder.

- The LCD monitor and the viewfinder are made with high-precision technology. However, black spots or bright spots of light (red, green or blue) may appear constantly on the LCD monitor or the viewfinder. These spots are not recorded on the tape. This is not due to any defect of the unit. (Effective dots: more than 99.99 %)

The cassette will not load properly.

- The battery's charge is low.
- Install a fully charged battery. (☞ pg. 11)

The memory card cannot be removed from the camcorder.

- Push in the memory card a few more times. (☞ pg. 14)

Picture does not appear on the LCD monitor.

- The viewfinder is pulled out and “PRIORITY” is set to “FINDER”.
- Push the viewfinder back in or set “PRIORITY” to “LCD”. (☞ pg. 15, 27, 29)
- The LCD monitor's brightness setting is too dark.
- Adjust the brightness of the LCD monitor. (☞ pg. 13)
- If the monitor is tilted upward 180 degrees, open the monitor fully. (☞ pg. 15)

An error indication (E01 – E04 or E06) appears.

- A malfunction of some kind has occurred. In this case the camcorder's functions become unusable.
- ☞ pg. 48.

The remote control does not work.

- “REMOTE” is set to “OFF”.
- Set “REMOTE” to “ON”. (☞ pg. 27, 29)
- The remote control does not point at the remote sensor.
- Point at the remote sensor. (☞ pg. 19)
- The remote control batteries are exhausted.
- Replace the batteries with fresh ones. (☞ pg. 19)

Warning Indications



Displays the battery remaining power.

Remaining power level

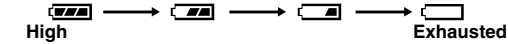

As the battery power comes close to nil, the battery indicator blinks.

When the battery power is exhausted, power turns off automatically.



Appears when no tape is loaded. (☞ pg. 14)

CHECK TAPE'S ERASE PROTECTION TAB

Appears when the erase protection tab is set to "SAVE" while the Power Switch is set to "A" or "M" and the VIDEO/MEMORY Switch is set to "VIDEO". (☞ pg. 12)

USE CLEANING CASSETTE

Appears if dirt is detected on the heads during recording. Use an optional cleaning cassette. (☞ pg. 49)

CONDENSATION OPERATION PAUSED PLEASE WAIT

Appears if condensation occurs. When this indication is displayed, wait more than 1 hour until condensation disappears.

TAPE!

Appears if a tape is not loaded when the Recording Start/ Stop Button or **SNAPSHOT** Button is pressed while the Power Switch is set to "A" or "M" and the VIDEO/MEMORY Switch is set to "VIDEO".

TAPE END

Appears when the tape ends during recording or playback.

SET DATE/TIME!

- Appears when the date/time is not set. (☞ pg. 12)
- Appears when the built-in clock (lithium) battery is discharged and the previously set date/time is erased. (☞ pg. 12)

LENS CAP

Appears for 5 seconds after power is turned on if the lens cap is attached or when it is dark.

A. DUB ERROR!

Appears if Audio Dubbing is attempted on a blank portion of a tape. (☞ pg. 40)

A. DUB ERROR!

<CANNOT DUB ON A LP RECORDED TAPE>
<CANNOT DUB ON A 16BIT RECORDING>
<CHECK TAPE'S ERASE PROTECTION TAB>

- Appears if Audio Dubbing is attempted on a tape recorded in the LP mode. (☞ pg. 40)
- Appears if Audio Dubbing is attempted on a tape recorded in 16-BIT audio. (☞ pg. 40)
- Appears if **A. DUB** (⊞) on the remote control is pressed when the erase protection tab is set to "SAVE". (☞ pg. 40)

INSERT ERROR!

Appears if Insert Editing is attempted on a blank portion of a tape. (☞ pg. 40)

INSERT ERROR!

<CANNOT EDIT ON A BLANK PORTION>
<CANNOT EDIT ON A LP RECORDED TAPE>
<CHECK TAPE'S ERASE PROTECTION TAB>

- Appears if Insert Editing is attempted on a blank portion of a tape.
- Appears if Insert Editing is attempted on a tape recorded in the LP mode. (☞ pg. 40)
- Appears if **INSERT** (Ⓢ) on the remote control is pressed when the erase protection tab is set to "SAVE". (☞ pg. 40)

MEMORY IS FULL

Appears when the memory card's memory is full and shooting is not possible.

COPYING FAILED

- Appears if dubbing of copyguarded signals is attempted while this camcorder is being used as a recorder.
- Appears in the following cases when dubbing from a tape to a memory card (as digital stills or video clips):
 - when no memory card is loaded.
 - when the memory card's memory is full.
 - when the memory card is not formatted.
 - when a write-protected SD Memory Card is loaded. (☞ pg. 24)

MEMORY CARD!

Appears if there is no memory card loaded when you attempt to record on a memory card or access data on a memory card.

PLEASE FORMAT

Appears when there is a problem with a memory card and its memory is corrupt, or it has not been initialized. Initialize the memory card. (☞ pg. 26)

NO IMAGES STORED

Appears if there are no image files stored in the memory card when you attempt memory card playback.

NO E-MAIL CLIP STORED

Appears if there are no video clip files stored in the memory card when you attempt memory card playback.

CARD ERROR!

Appears when the camcorder does not recognize the loaded memory card. Remove the memory card once and insert it again. Repeat these procedures until no indication appears. If the indication still appears, the memory card is corrupted.

UNSUPPORTED FILE!

Appears when playing back a file that is not compatible with DCF or a file with a size that is not compatible with this camcorder.

CHECK CARD'S WRITE PROTECTION SWITCH

- Appears when you attempt to shoot digital still images when the write protection tab on the SD Memory Card is set to the "LOCK" position.
- Appears when you attempt MEMORY SELECT menu operation with a write-protected SD Memory Card loaded.

**E01, E02 or E06
UNIT IN SAFEGUARD MODE REMOVE AND
REATTACH BATTERY**

The error indications (E01, E02 or E06) show what type of malfunction has occurred. When an error indication appears, the camcorder turns off automatically. Remove the power supply (battery, etc.) and wait a few minutes for the indication to clear. When it does, you can resume using the camcorder. If the indication remains, consult your nearest JVC dealer.

**E03 or E04
UNIT IN SAFEGUARD MODE EJECT AND REINSERT
TAPE**

The error indications (E03 or E04) show what type of malfunction has occurred. When an error indication appears, the camcorder turns off automatically. Eject the cassette once and re-insert it, then check if the indication clears. When it does, you can resume using the camcorder. If the indication remains, consult your nearest JVC dealer.

Cleaning The Camcorder

Before cleaning, turn off the camcorder and remove the battery pack and AC Adapter.

To clean the exterior

Wipe gently with a soft cloth. Put the cloth in diluted mild soap and wring it well to wipe off heavy dirt. Then wipe again with a dry cloth.

To clean the LCD monitor

Wipe gently with a soft cloth. Be careful not to damage the monitor. Close the LCD monitor.

To clean the lens

Blow it with a blower brush, then wipe gently with lens cleaning paper.

NOTES:

- Avoid using strong cleaning agents such as benzine or alcohol.
- Cleaning should be done only after the battery pack has been removed or other power units have been disconnected.
- Mould may form if the lens is left dirty.
- When using a cleaner or chemically treated cloth refer to the cautions of each product.
- To clean the viewfinder, please consult your nearest JVC dealer.

AC Adapter

When using the AC Adapter in areas other than the USA The provided AC Adapter features automatic voltage selection in the AC range from 110 V to 240 V.

USING HOUSEHOLD AC PLUG ADAPTER

In case of connecting the unit's power cord to an AC wall outlet other than American National Standard C73 series type use an AC plug adapter, called a "Siemens Plug", as shown.

For this AC plug adapter, consult your nearest JVC dealer.

Plug adapter

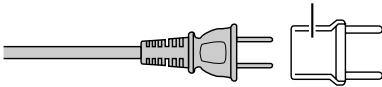

Battery Packs

The supplied battery pack is a lithium-ion battery. Before using the supplied battery pack or an optional battery pack, be sure to read the following cautions:

• To avoid hazards

- ... do not burn.
- ... do not short-circuit the terminals. When transporting, make sure the provided battery cap is attached to the battery. If the battery cap is misplaced, carry the battery in a plastic bag.
- ... do not modify or disassemble.
- ... do not expose the battery to temperatures exceeding 60°C (140°F), as this may cause the battery to overheat, explode or catch fire.
- ... use only specified chargers.

• To prevent damage and prolong service life

- ... do not subject to unnecessary shock.
- ... charge in an environment where temperatures are within the tolerances shown in the chart below. This is a chemical reaction type battery — cooler temperatures impede chemical reaction, while warmer temperatures can prevent complete charging.
- ... store in a cool, dry place. Extended exposure to high temperatures will increase natural discharge and shorten service life.
- ... fully charge and then fully discharge the battery every 6 months when storing the battery pack over a long period time.
- ... remove from charger or powered unit when not in use, as some machines use current even when switched off.

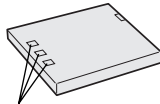

Terminals

NOTES:

- It is recommended that only genuine JVC batteries are used in this camcorder. Using generic non-JVC batteries can cause damage to the internal charging circuitry.
- It is normal for the battery pack to be warm after charging, or after use.

Temperature Range Specifications

Charging: 10°C to 35°C (50°F to 95°F)

Operation: 0°C to 40°C (32°F to 104°F)

Storage: -20°C to 50°C (-4°F to 122°F)

- The lower the temperature, the longer recharging takes.
- Charging times are for a fully discharged battery pack.

Cassettes

To properly use and store your cassettes, be sure to read the following cautions:

• During use

- ... make sure the cassette bears the Mini DV mark.

- ... be aware that recording onto prerecorded tapes automatically erases the previously recorded video and audio signals.
- ... make sure the cassette is positioned properly when inserting.
- ... do not load and unload the cassette repeatedly without allowing the tape to run at all. This slackens the tape and can result in damage.
- ... do not open the front tape cover. This exposes the tape to fingerprints and dust.
- **Store cassettes**
 - ... away from heaters or other heat sources.
 - ... out of direct sunlight.
 - ... where they won't be subject to unnecessary shock or vibration.
 - ... where they won't be exposed to strong magnetic fields (such as those generated by motors, transformers or magnets).
 - ... vertically, in their original cases.

Memory Cards

To properly use and store your memory cards, be sure to read the following cautions:

• During use

- ... make sure the memory card bears the SD or MultiMediaCard mark.
- ... make sure the memory card is positioned properly when inserting.
- **While the memory card is being accessed (during recording, playback, deletion, initialization, etc.)**
 - ... never unload the memory card and never turn off the camcorder.
- **Store memory cards**
 - ... away from heaters or other heat sources.
 - ... out of direct sunlight.
 - ... where they won't be subject to unnecessary shock or vibration.
 - ... where they won't be exposed to strong magnetic fields (such as those generated by motors, transformers or magnets).

LCD Monitor

• To prevent damage to the LCD monitor, DO NOT

- ... push it strongly or apply any shocks.
- ... place the camcorder with the LCD monitor on the bottom.
- **To prolong service life**
 - ... avoid rubbing it with coarse cloth.
- **Be aware of the following phenomena for LCD monitor use. These are not malfunctions**
 - ... While using the camcorder, the surface around the LCD monitor and/or the back of the LCD monitor may heat up.
 - ... If you leave power on for a long time, the surface around the LCD monitor becomes hot.

Main Unit

• For safety, DO NOT

- ... open the camcorder's chassis.
- ... disassemble or modify the unit.
- ... short-circuit the terminals of the battery pack. Keep it away from metallic objects when not in use.
- ... allow inflammables, water or metallic objects to enter the unit.
- ... remove the battery pack or disconnect the power supply while the power is on.
- ... leave the battery pack attached when the camcorder is not in use.
- **Avoid using the unit**
 - ... in places subject to excessive humidity or dust.
 - ... in places subject to soot or steam such as near a cooking stove.
 - ... in places subject to excessive shock or vibration.
 - ... near a television set.
 - ... near appliances generating strong magnetic or electric fields (speakers, broadcasting antennas, etc.).

...in places subject to extremely high (over 40°C or 104°F) or extremely low (under 0°C or 32°F) temperatures.

● **DO NOT leave the unit**

- ...in places of over 50°C (122°F).
- ...in places where humidity is extremely low (below 35%) or extremely high (above 80%).
- ...in direct sunlight.
- ...in a closed car in summer.
- ...near a heater.

● **To protect the unit, DO NOT**

- ...allow it to become wet.
- ...drop the unit or strike it against hard objects.
- ...subject it to shock or excessive vibration during transportation.
- ...keep the lens directed at extremely bright objects for long periods.
- ...expose the lens and viewfinder's lens to direct sunlight.
- ...carry it by holding the LCD monitor or the viewfinder.
- ...swing it excessively when using the hand strap or the grip.
- ...swing the soft camera case excessively when the camcorder is inside it.

● **Dirty heads can cause the following problems:**



- ...No picture during playback.
- ...Blocks of noise appear during playback.
- ...During recording or playback, the Head Clog Warning indicator "⊗" appears.

...Recording cannot be performed properly. In such cases, use an optional cleaning cassette. Insert it and play back. If the cassette is used more than once consecutively, damage to the video heads may result. After the camcorder plays back for about 20 seconds, it stops automatically. Also refer to the cleaning cassette's instructions.

If, after using the cleaning cassette, the problems still exist, consult your nearest JVC dealer.

Mechanical moving parts used to move the video heads and video tape tend to become dirty and worn out over time. In order to maintain a clear picture at all times, periodic check-ups are recommended after using the unit for about 1,000 hours. For periodic check-ups please consult your nearest JVC dealer.

How To Handle A CD-ROM

- Take care not to soil or scratch the mirror surface (opposite to the printed surface). Do not write anything or put a sticker on either the front or back surface. If the CD-ROM gets dirty, gently wipe it with a soft cloth outward from the center hole.
- Do not use conventional disc cleaners or cleaning spray.
- Do not bend the CD-ROM or touch its mirror surface.
- Do not store your CD-ROM in a dusty, hot or humid environment. Keep it away from direct sunlight.

Serious malfunctioning

If malfunctioning occurs, stop using the unit immediately and consult your local JVC dealer.

The camcorder is a microcomputer-controlled device. External noise and interference (from a TV, a radio, etc.) might prevent it from functioning properly. In such cases, first disconnect its power supply unit (battery pack, AC Adapter, etc.) and wait a few minutes and then re-connect it and proceed as usual from the beginning.

Declaration of Conformity

Model Number : GR-DX307U
 Trade Name : JVC
 Responsible party : JVC AMERICAS CORP.
 Address : 1700 Valley Road Wayne, N. J. 07470
 Telephone Number : 973-317-5000

This device complies with Part 15 of FCC Rules. Operation is subject to the following two conditions: (1) This device may not cause harmful interference, and (2) this device must accept any interference received, including interference that may cause undesired operation.

Changes or modifications not approved by JVC could void the user's authority to operate the equipment. This equipment has been tested and found to comply with the limits for a Class B digital device, pursuant to Part 15 of the FCC Rules. These limits are designed to provide reasonable protection against harmful interference in a residential installation. This equipment generates, uses, and can radiate radio frequency energy and, if not installed and used in accordance with the instructions, may cause harmful interference to radio communications. However, there is no guarantee that interference will not occur in a particular installation. If this equipment does cause harmful interference to radio or television reception, which can be determined by turning the equipment off and on, the user is encouraged to try to correct the interference by one or more of the following measures:
 Reorient or relocate the receiving antenna.
 Increase the separation between the equipment and receiver.
 Connect the equipment into an outlet on a circuit different from that to which the receiver is connected.
 Consult the dealer or an experienced radio/ TV technician for help.

This Class B digital apparatus complies with Canadian ICES-003.
 Cet appareil numérique de la classe B est conforme à la norme NMB-003 du Canada.

About moisture condensation

- You have observed that pouring a cold liquid into a glass will cause drops of water to form on the glass' outer surface. This same phenomenon occurs on the head drum of a camcorder when it is moved from a cool place to a warm place, after heating a cold room, under extremely humid conditions or in a place directly subjected to the cool air from an air conditioner.
- Moisture on the head drum can cause severe damage to the video tape, and can lead to internal damage to the camcorder itself.

Camcorder

For General

Power supply

DC 11 V (Using AC Adapter)
DC 7.2 V (Using battery pack)

Power consumption

Approx. 3.3 W (4.0 W*) (LCD monitor off, viewfinder on)
Approx. 4.1 W (4.8 W*) (LCD monitor on, viewfinder off)
Approx. 6.7 W (Maximum; when charging a battery)

* Using LED Light

Dimensions (W x H x D)

52 mm x 94 mm x 95 mm (2-1/16" x 3-3/4" x 3-3/4")
(with the LCD monitor closed and the viewfinder pushed back in)

Weight

Approx. 445 g (0.99 lbs)
(without battery, cassette, memory card, lens cap and grip strap)

Approx. 520 g (1.2 lbs)

(incl. battery, cassette, memory card, lens cap and grip strap)

Operating temperature

0°C to 40°C (32°F to 104°F)

Operating humidity

35% to 80%

Storage temperature

-20°C to 50°C (-4°F to 122°F)

Pickup

1/4.5" CCD

Lens

F 1.8, f = 3.2 mm to 32 mm, 10:1 power zoom lens

Filter diameter

ø27 mm

LCD monitor

3.0" diagonally measured, LCD panel/TFT active matrix system

Viewfinder

Electronic viewfinder with 0.3" color LCD

Speaker

Monaural

LED Light

Effective distance: 1.5 m (5 ft)

For Digital Video Camera

Format

DV format (SD mode)

Signal format

NTSC standard

Recording/Playback format

Video: Digital component recording
Audio: PCM digital recording, 32 kHz 4-channel (12-BIT),
48 kHz 2-channel (16-BIT)

Cassette

Mini DV cassette

Tape speed

SP: 18.8 mm/s, LP: 12.5 mm/s

Maximum recording time (using 80 min. cassette)

SP: 80 min., LP: 120 min.

For Digital Still Camera

Storage media

SD Memory Card/MultiMediaCard

Compression system

Still image: JPEG (compatible)
Moving image: MPEG4 (compatible)

File size

Still image:
4 modes (1600 x 1200 pixels/1280 x 960 pixels/
1024 x 768 pixels/640 x 480 pixels)
Moving image:

1 mode (160 x 120 pixels)

Picture quality

2 modes (FINE/STANDARD)

Approximate number of storable images

☞ pg. 21

For Connectors

AV

S-Video input:

Y: 0.8 V to 1.2 V (p-p), 75 Ω, analog

C: 0.2 V to 0.4 V (p-p), 75 Ω, analog

S-Video output:

Y: 1.0 V (p-p), 75 Ω, analog

C: 0.29 V (p-p), 75 Ω, analog

Video input: 0.8 V to 1.2 V (p-p), 75 Ω, analog

Video output: 1.0 V (p-p), 75 Ω, analog

Audio input: 300 mV (rms), 50 kΩ, analog, stereo

Audio output: 300 mV (rms), 1 kΩ, analog, stereo

Edit: ø3.5 mm, 2-pole

Microphone input

ø3.5 mm, stereo

DV

Input/output: 4-pin, IEEE 1394 compliant

USB

Mini USB-B type, USB 1.1/2.0 (Full speed; 12Mbps)
compliant

AC Adapter

Power requirement

AC 110 V to 240 V~, 50 Hz/60 Hz

Output

DC 11 V , 1 A

Specifications shown are for SP mode unless otherwise indicated. E & O.E. Design and specifications subject to change without notice.

A		N	
AC Adapter	11	Navigation	28, 35
Animation	28	Night-Alive	32
Audio Dubbing	40	P	
B		Picture Quality	30
Backlight Compensation	33	Playback Sound	30
Battery Pack	11, 49	Playback Special Effects	20
Beep	29	Power-Linked Operation	12
Blank Search	18	Program AE With Special Effects	35
C		R	
Changing The Menu Settings	27 – 31	Random Assemble Editing	41 – 44
Charging The Battery Pack	11	Recording Capacity	
Connection To A Personal Computer	39	Memory Card	21, 24
Connections To A TV Or VCR	18	Tape	15
D		Recording Media Selection	30
Date/Time Settings	12	Remote Control	19
Deleting Files	25	Resetting The File Name	24
Demonstration Mode	29	S	
Digital Image Stabilization (DIS)	28	Self-Timer	31
DPOF Setting (Digital Print Order Format)	26	Slow-Motion Playback	20
Dubbing	24, 37, 38	Snapshot Mode	28
E		Sound Mode	28, 30
E-Mail Clip Recording	24	Speaker Volume	17
Exposure Control	33	Specifications	51
I		Spot Exposure Control	33
Image Size	30	T	
Initializing A Memory Card	26	Tally Lamp	15, 29
Insert Editing	40	Tape Speed (REC MODE)	28, 30
Iris Lock	33	Telephoto Setting	28
L		Time Code	17, 30
LCD Monitor and Viewfinder	13, 15	Tripod Mounting	13
LED Light	31	Troubleshooting	45
Loading A Cassette	14	W	
Loading A Memory Card	14	Warning Indications	47
M		White Balance	34
Manual Focus	32	Wide Mode	29
Memory Card	14, 49	Wipe Or Fader Effects	34
Motor Drive Mode	32	Z	
		Zooming	16, 20, 28
		5-Second Recording	32

JVC

VICTOR COMPANY OF JAPAN, LIMITED